



ITMO UNIVERSITY

IoT Enabled Sustainable Development in St Petersburg (bloTope project)

sadov@mail.ifmo.ru

Oleg Sadov

<http://sdn.ifmo.ru/>



ITMO UNIVERSITY

bloTope – building an IoT OPen innovation Ecosystem for connected smart objects

<http://www.biotope-project.eu>

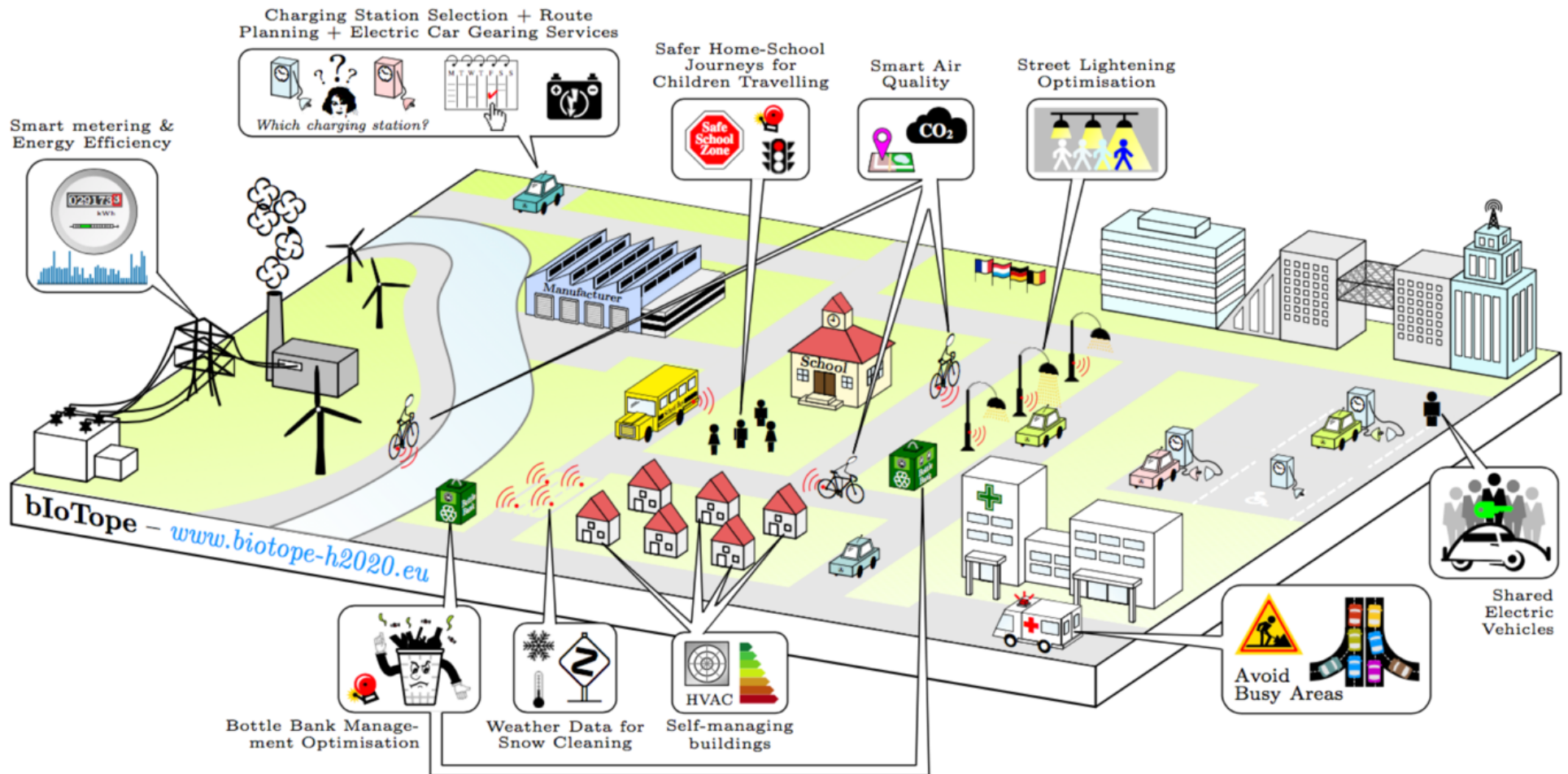



BioTope Objectives & Standards

More than 20 partners from 10 countries.

The key objectives of the bloTope project include the following:

- Provide the necessary standardised Open APIs to enable interoperability between today's vertical IoT silos
- Enable new forms of co-creation of services ranging from simple data collection and processing, to intelligent, situation aware and self-adaptive support of everyday work and life
- Establish a robust IoT framework for security, privacy & trust that facilitates the responsible access and ownership of data
- Develop large-scale pilots in smart cities to provide proofs-of-concept of bloTope enabled SoS ecosystems
- Maintain, grow and sustain the socio-technical and business models of bloTope ecosystems by establishing a governance roadmap for ecosystem evolution

Standards for IoT and Technology Innovations:

bloTope technologies enable the publication, consumption and composition of heterogeneous information sources and services from across multiple systems (OpenIoT, FIWARE, city dashboards...). Full advantage is taken of recent IoT standards, notably the O-MI (Open Messaging Interface) and O-DF (Open Data Format) standards, while an "Everything as a Service" design enables rapid development of new IoT systems and reduced development costs.

Smart Grids Energy Efficiency	Implementable in any of the involved cities	FORUM VIRIUM HELSINKI A! UNIVERITEIT LIJNENBOURG
Shared Electric Vehicles	Implementable in any of the involved cities	FORUM VIRIUM HELSINKI BMW OpenDataSoft
Smart Mobility for Emergency Services	Implementable in any of the involved cities	FORUM VIRIUM HELSINKI A! IRISNET clbg.brussels OpenDataSoft
Safe Home School Journeys	Implementable in any of the involved cities	IRISNET clbg.brussels OpenDataSoft
Smart Home Energy Management	Implementable in any of the involved cities	GRANDLYON EPFL Cityzen
Smart Home Energy Optimisation	Implementable in any of the involved cities	GRANDLYON EPFL Cityzen
Smart Home Snow Cleaning	Implementable in any of the involved cities	GRANDLYON EPFL Cityzen
Charging Station Selection + Route Planning + Electric Car Gearing Services	Potentially implementable in any of the involved cities	Fraunhofer IAS BIBA
Smart Home Heating & Equipment	Implementable in any of the involved cities	enervent HOLONIS A! ControlThings
Smart Air Quality	Implementable in any of the involved cities	CSIRO UNIVERITEIT LIJNENBOURG itrust consulting



ITMO projects requirements

This research is funded by the Ministry of Education and Science of the Russian Federation under the Grant Agreement **RFMEFI58716X0031**.

System for dynamic status monitoring and management of waste management for city/district administrations and other users.

The architecture of the prototype of a solid waste collection system based on IoT technologies should establish the relationship between the following system components:

- Cloud system of decision support and management system for waste export;
- Web application for organizations-carriers;
- Web application for government agencies;
- Mobile application for drivers;
- Mobile application for workers of housing and communal services;
- Web application for citizens.



SWM integration

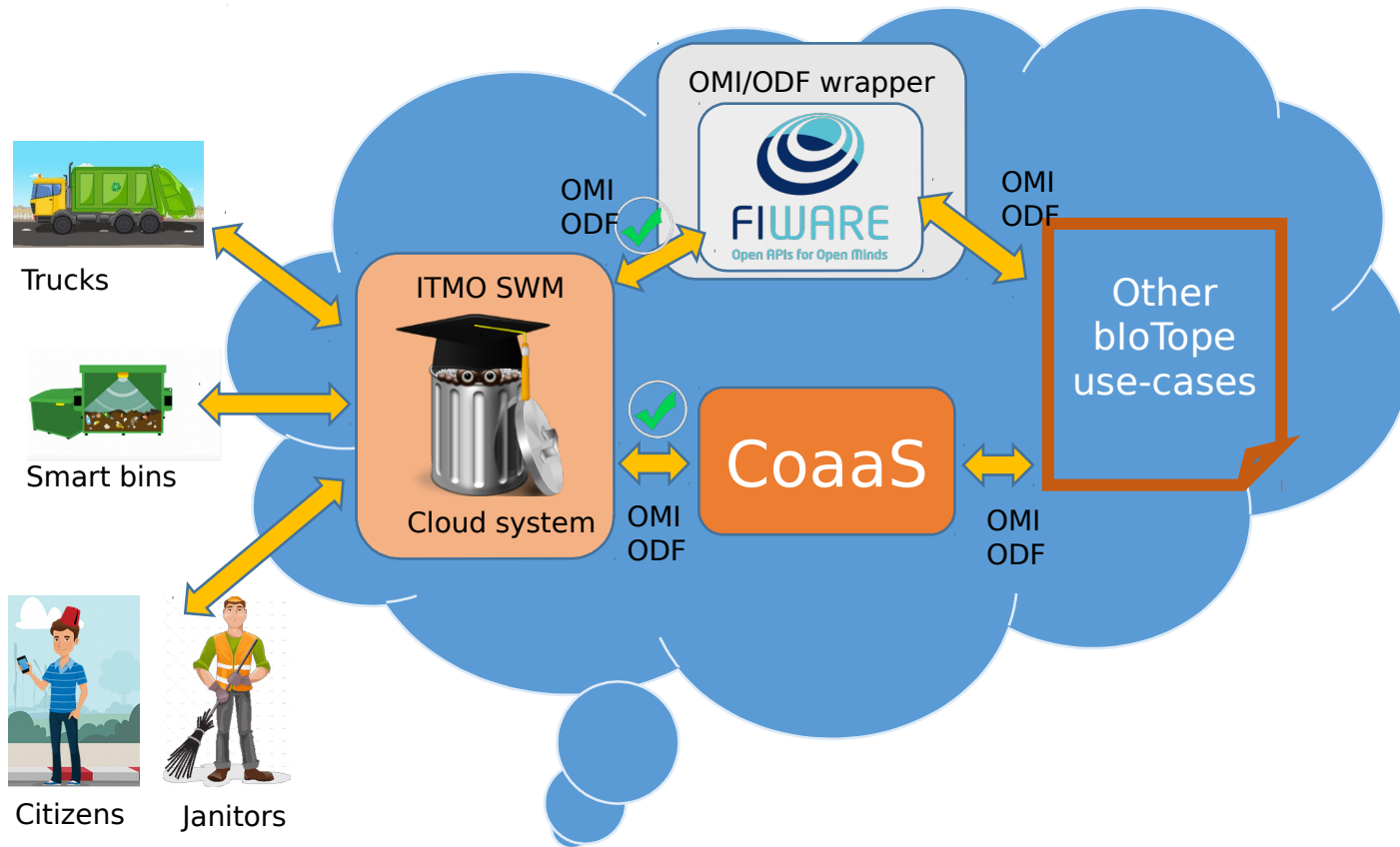



SWM general architecture

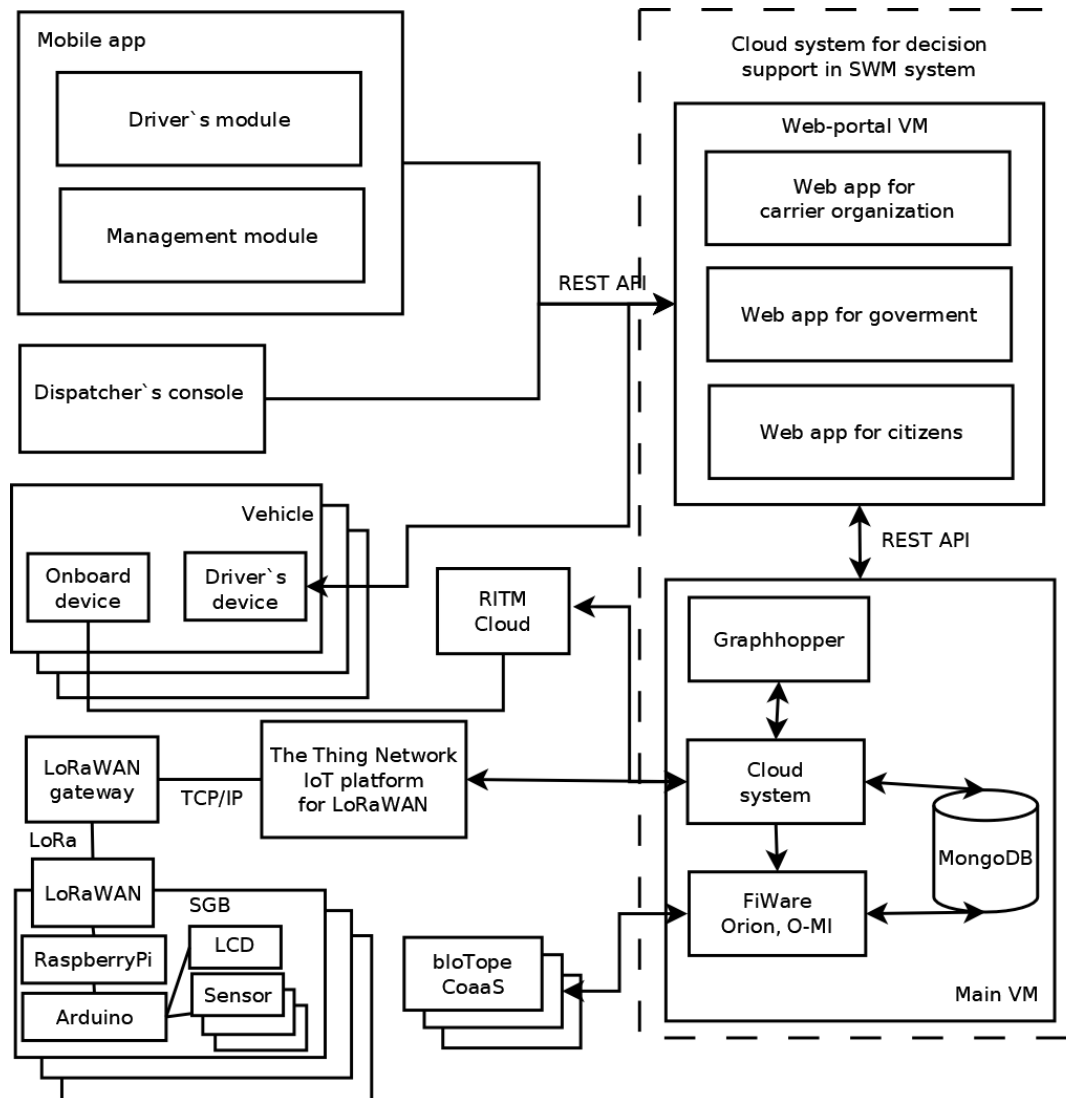

Main components:

- Cloud system
- Web apps
- Mobile apps
- Onboard devices
- SGB

Communication via:

- REST API
- LoRaWAN
- OMI
- NGSI



Web application for dispatchers of SWM operators

- City dashboard
- Traffic jams and road works
- Complaints & Reviews
- Automated scheduling of vehicles
- Receiving driver messages
- Reports on the quality of the collection of solid waste Driving quality control

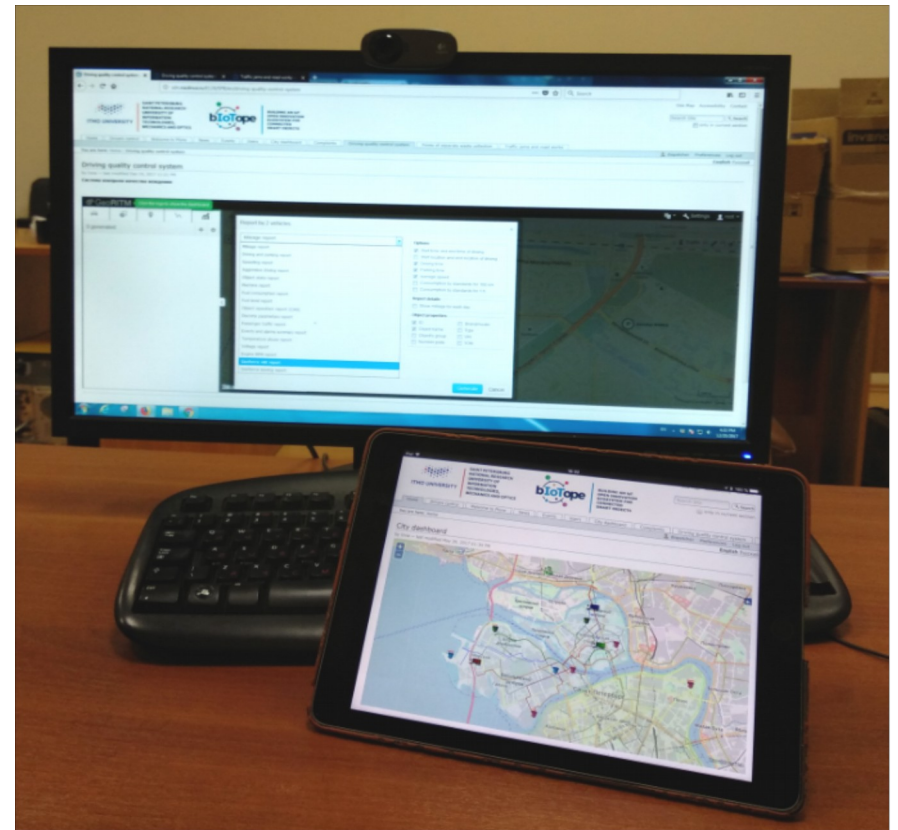



ITMO UNIVERSITY

Smart Garbage Bin (SGB)



Installing in SGB

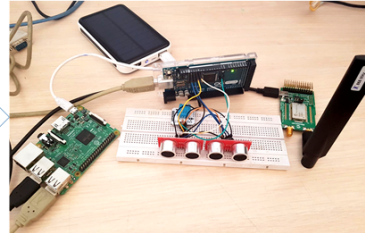

LoRaWAN

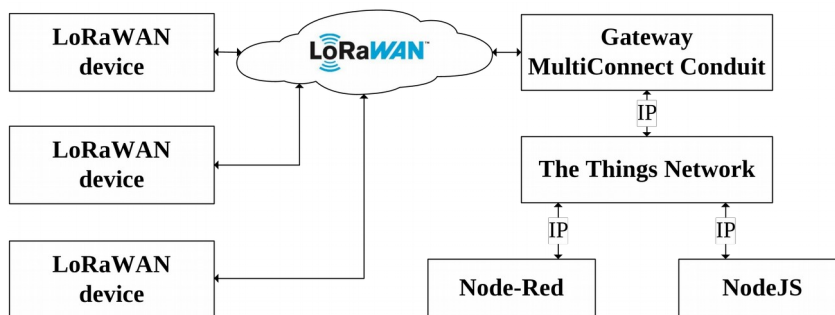
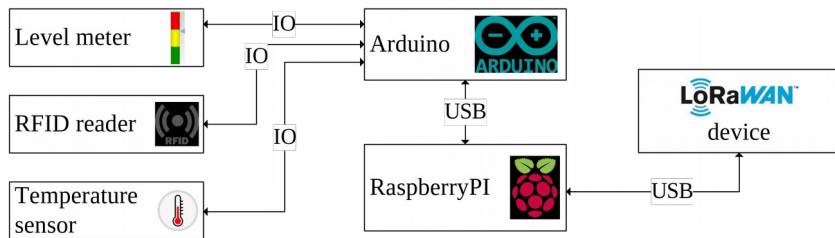

- We use Arduino board as a bridge between sensors and Raspberry Pi (RPI) platform.
- RaspberryPi aggregates raw data and represent a bridge to Cloud through LoRaWAN stack.
- The main purpose of the gateway is to ensure reliable package forwarding to IP-network.
- The Things Network (TTN) service is a cloud service for monitoring the queue of events from devices, decrypting packets, routing data to processing services



SWM mobile app. principle of work

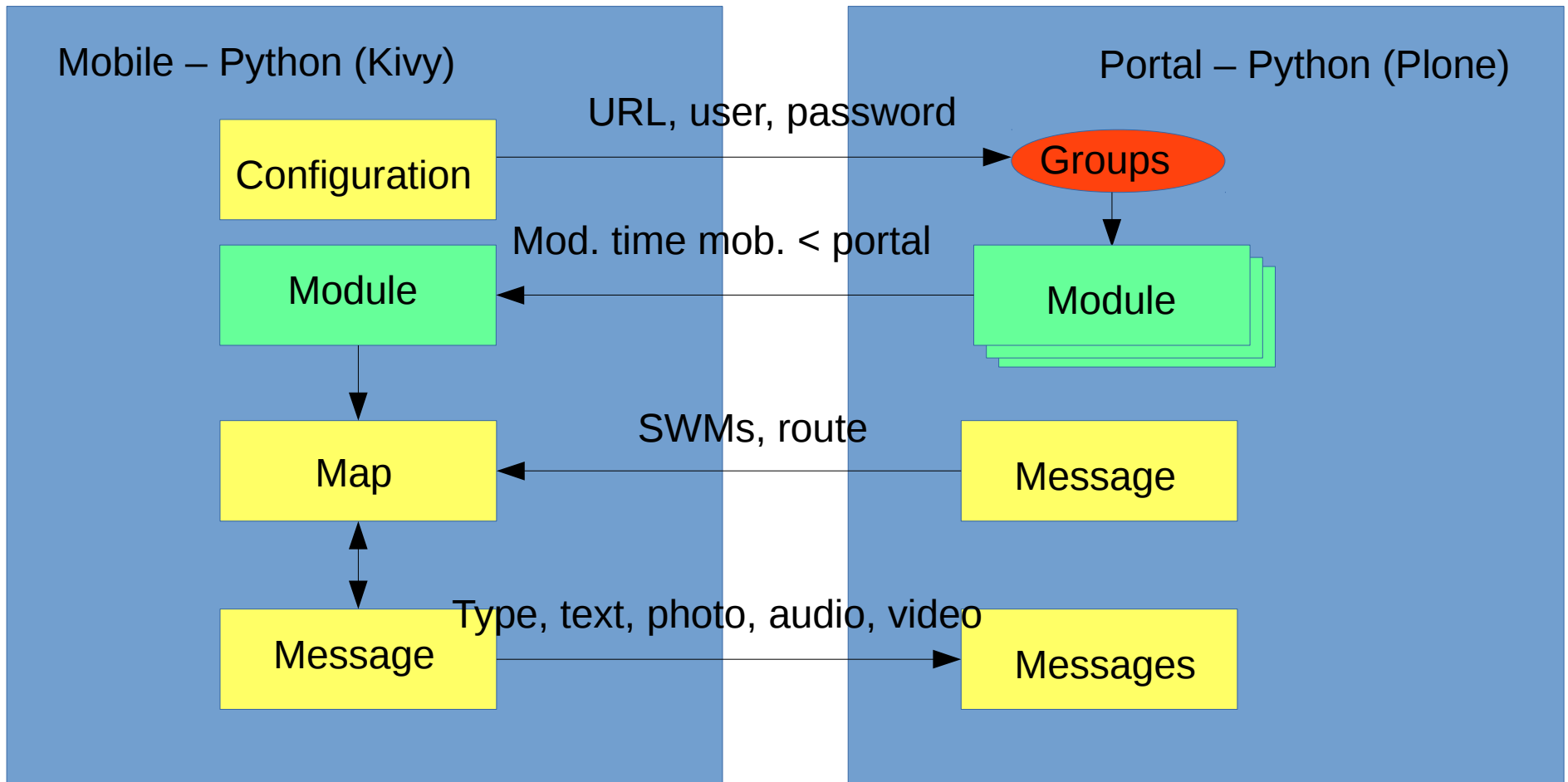



ITMO UNIVERSITY

Mobile application on different devices

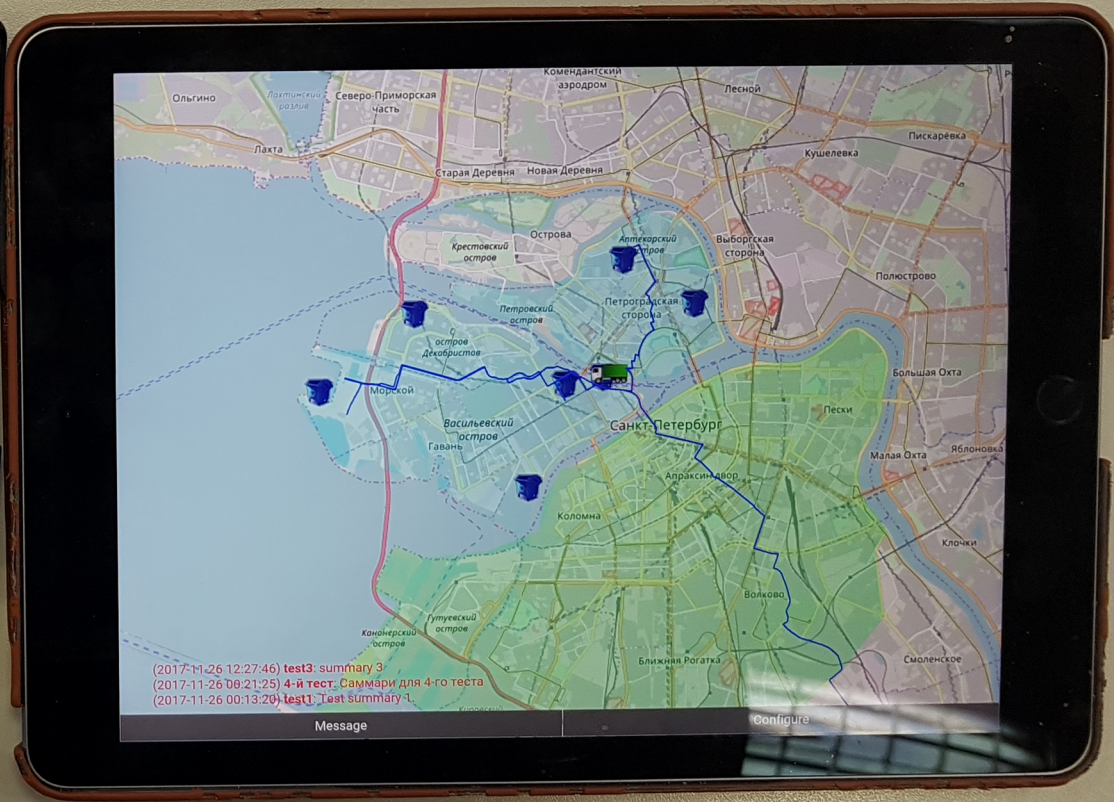
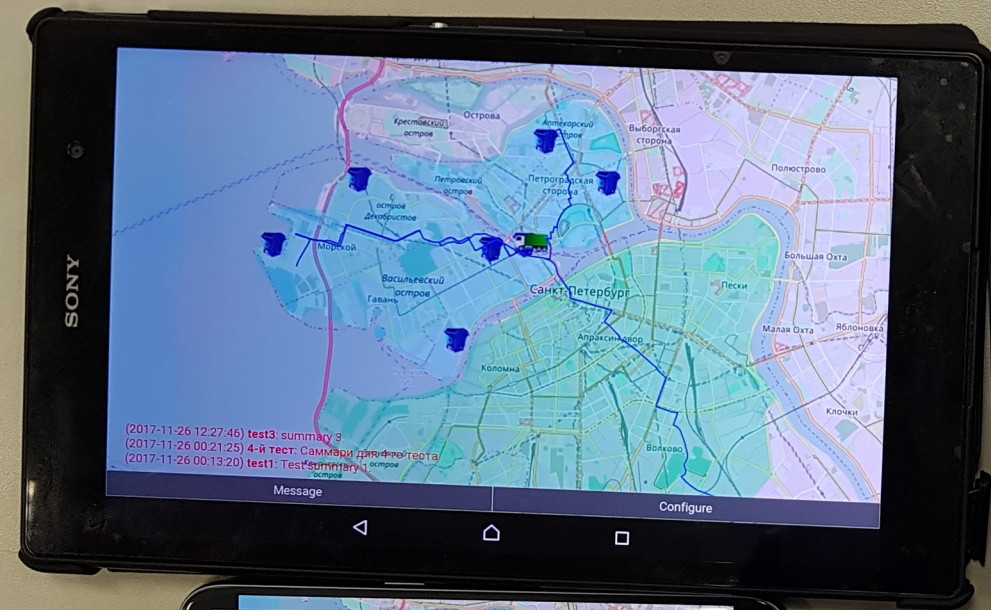



Waste Management Ontology

- Development environment - Protégé
- Source language - OWL
- [Ontology online](#)

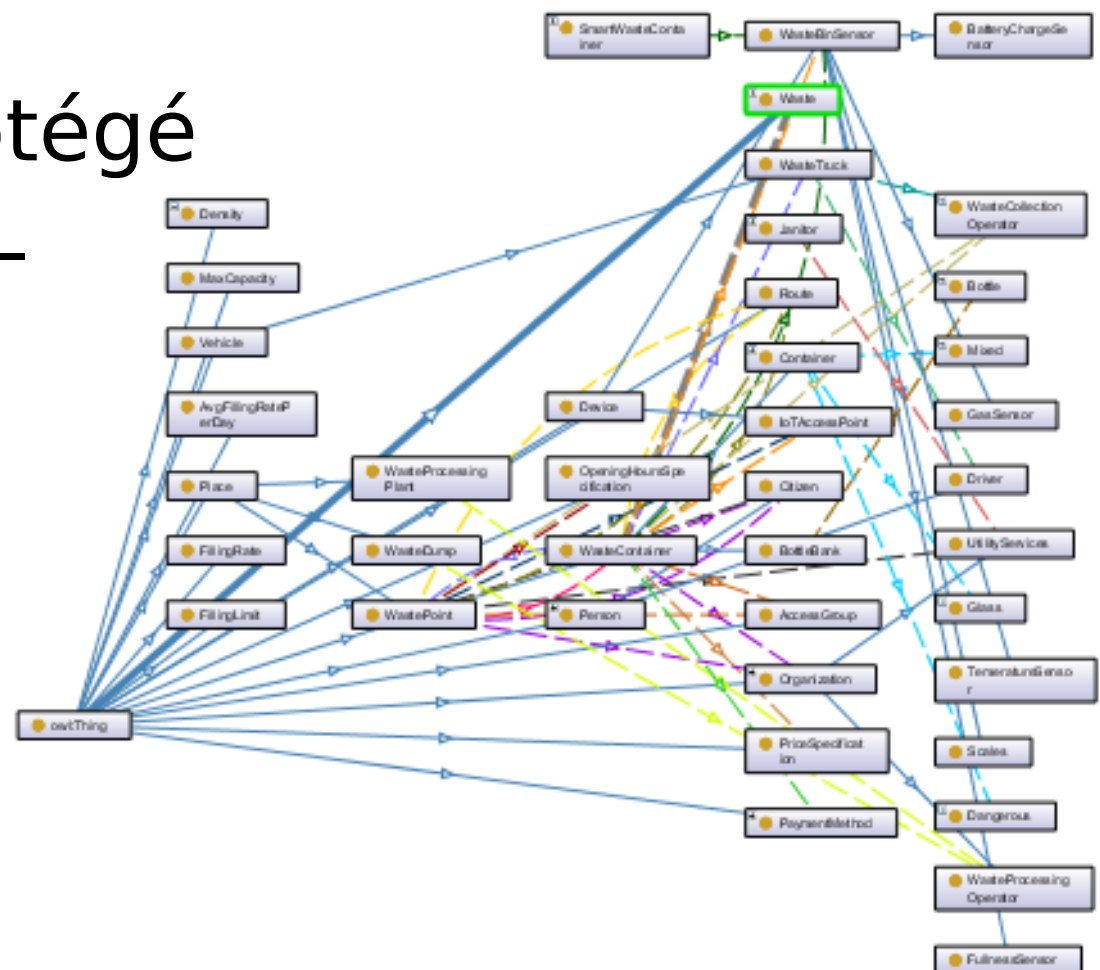



CoaaS

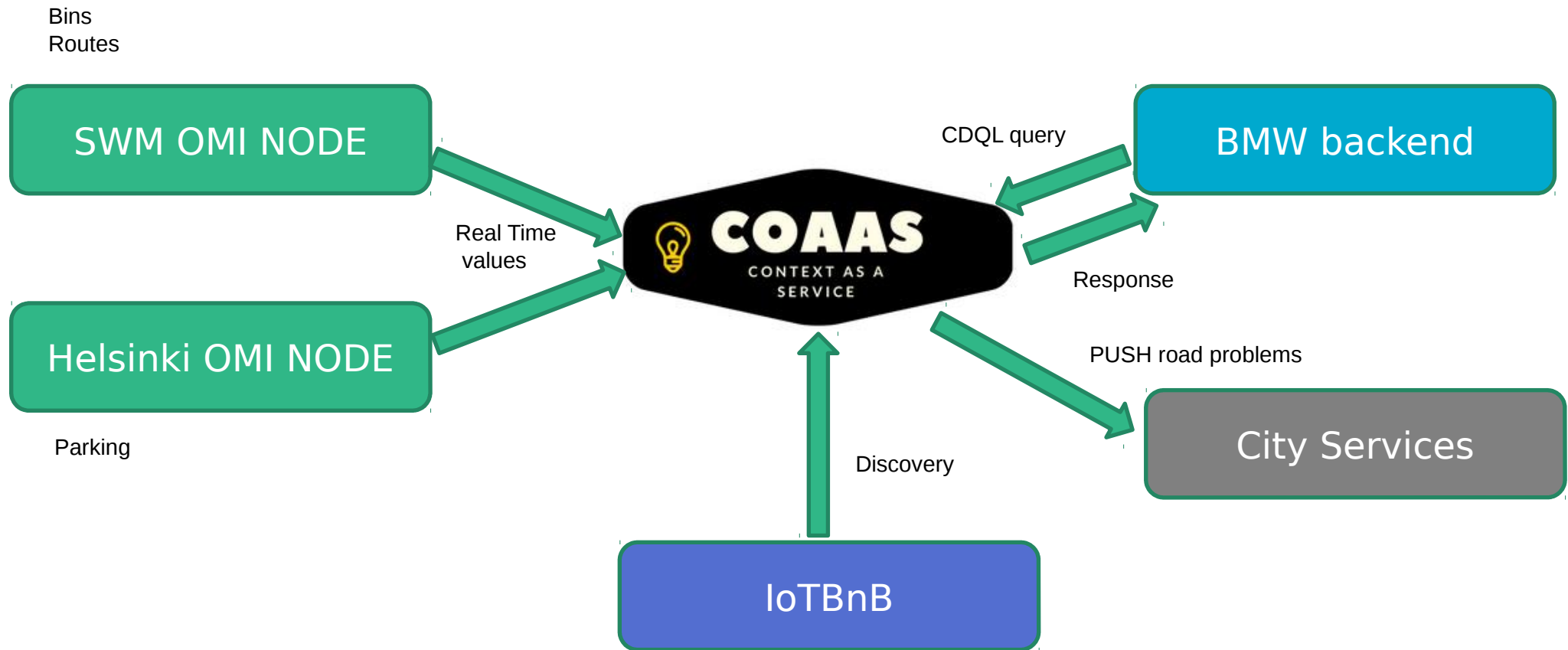



ITMO UNIVERSITY

Smart City

The test data used in the works should correspond to the standard data of a modern metropolis with a population of more than one million people.

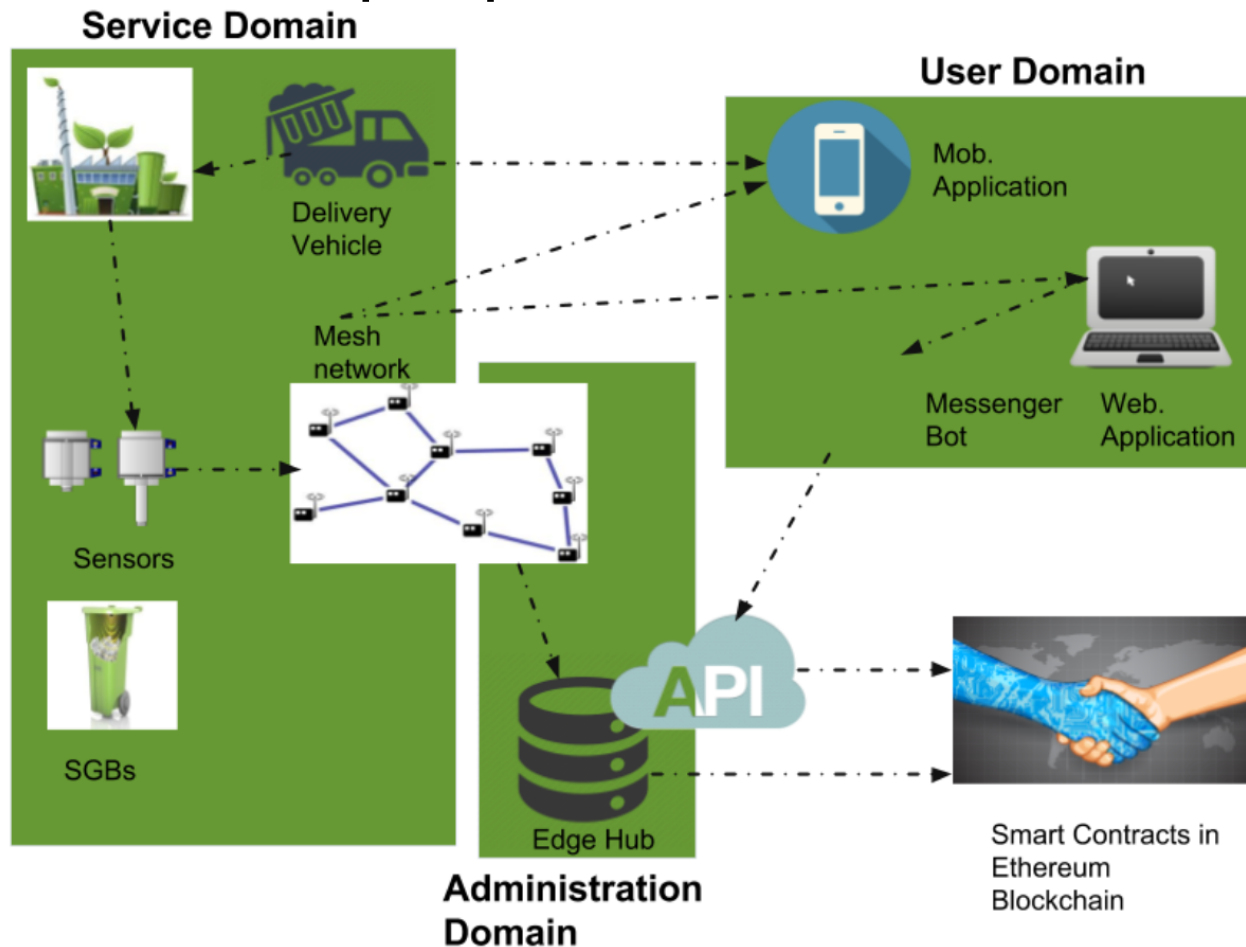



ITMO UNIVERSITY

Blockchain Ecosystem

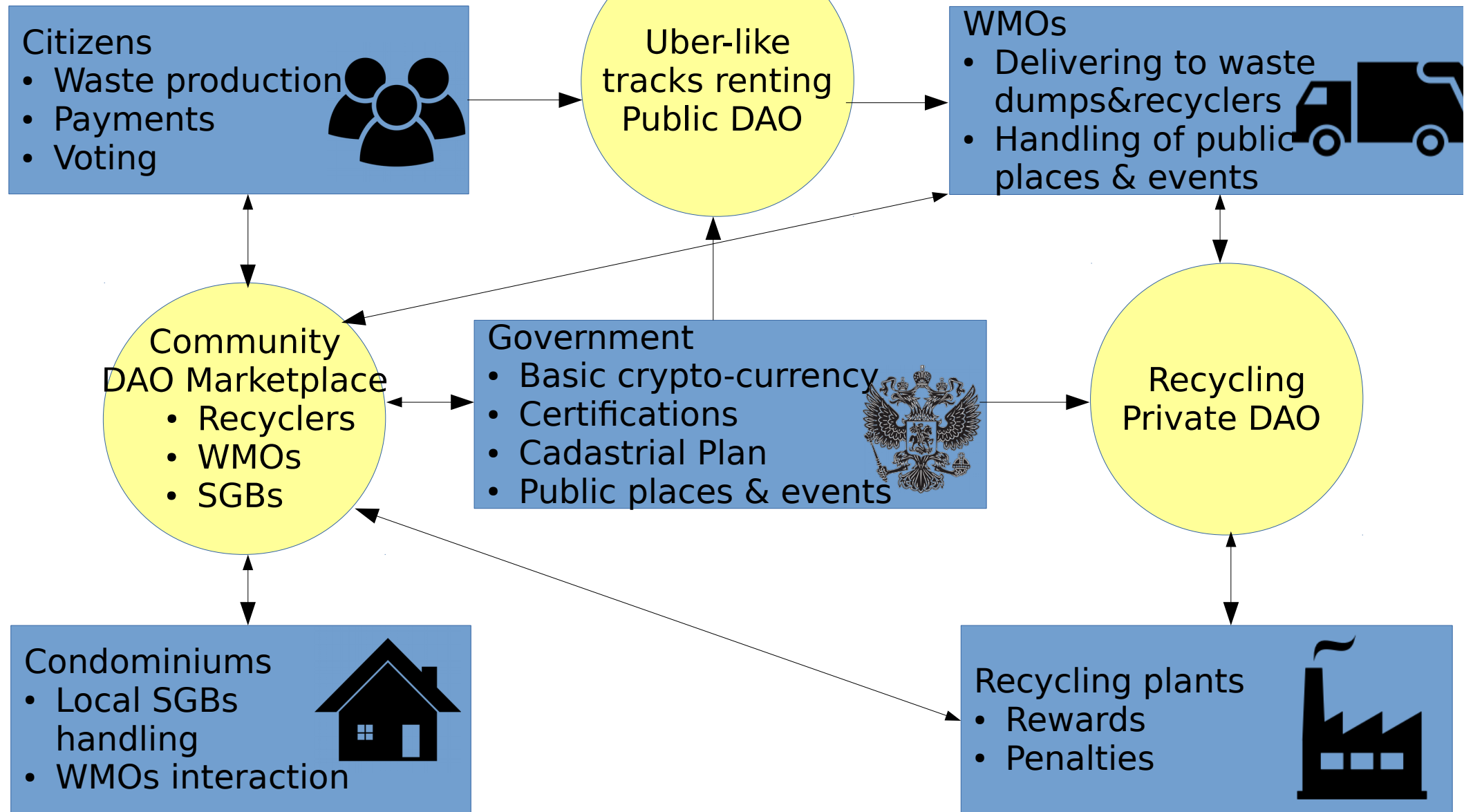



ITMO UNIVERSITY

R&D support:

- EU HORIZON 2020 bloTope project
- Ministry of Education and Science of the Russian Federation under the Grant Agreement **RFMEFI58716X0031**
- Erasmus Mundus Joint Master Degree (EMJMD) in Pervasive Computing and Communications for Sustainable Development (PERCCOM)

Resources:

- <http://sdn.ifmo.ru/waste-management-system>
- <https://github.com/itmo-swm>