

Huawei Storage Certification Training

HCIA-Storage Lab Guide

V4.5



HUAWEI

HUAWEI TECHNOLOGIES CO., LTD.

Copyright © Huawei Technologies Co., Ltd. 2020. All rights reserved.

No part of this document may be reproduced or transmitted in any form or by any means without prior written consent of Huawei Technologies Co., Ltd.

Trademarks and Permissions



and other Huawei trademarks are trademarks of Huawei Technologies Co., Ltd.

All other trademarks and trade names mentioned in this document are the property of their respective holders.

Notice

The purchased products, services and features are stipulated by the contract made between Huawei and the customer. All or part of the products, services and features described in this document may not be within the purchase scope or the usage scope. Unless otherwise specified in the contract, all statements, information, and recommendations in this document are provided "AS IS" without warranties, guarantees or representations of any kind, either express or implied.

The information in this document is subject to change without notice. Every effort has been made in the preparation of this document to ensure accuracy of the contents, but all statements, information, and recommendations in this document do not constitute a warranty of any kind, express or implied.

Huawei Technologies Co., Ltd.

Address: Huawei Industrial Base Bantian, Longgang Shenzhen 518129
People's Republic of China

Website: <http://e.huawei.com>

Huawei Certificate System

Huawei Certification follows the "platform + ecosystem" development strategy, which is a new collaborative architecture of ICT infrastructure based on "Cloud-Pipe-Terminal". Huawei has set up a complete certification system consisting of three categories: ICT infrastructure certification, Platform and Service certification and ICT vertical certification, and grants Huawei certification the only all-range technical certification in the industry.

Huawei offers three levels of certification: Huawei Certified ICT Associate (HCIA), Huawei Certified ICT Professional (HCIP), and Huawei Certified ICT Expert (HCIE).

Huawei Certified ICT Associate-Storage (HCIA-Storage) is designed for Huawei engineers, students and ICT industry personnel. HCIA-Storage covers knowledge about storage technology trends, storage basic technologies, storage common advanced technologies, storage business continuity solutions and storage system O&M management.

The HCIA-Storage certificate system introduces you to the industry and market, helps you in innovation, and enables you to stand atop the Storage frontiers.

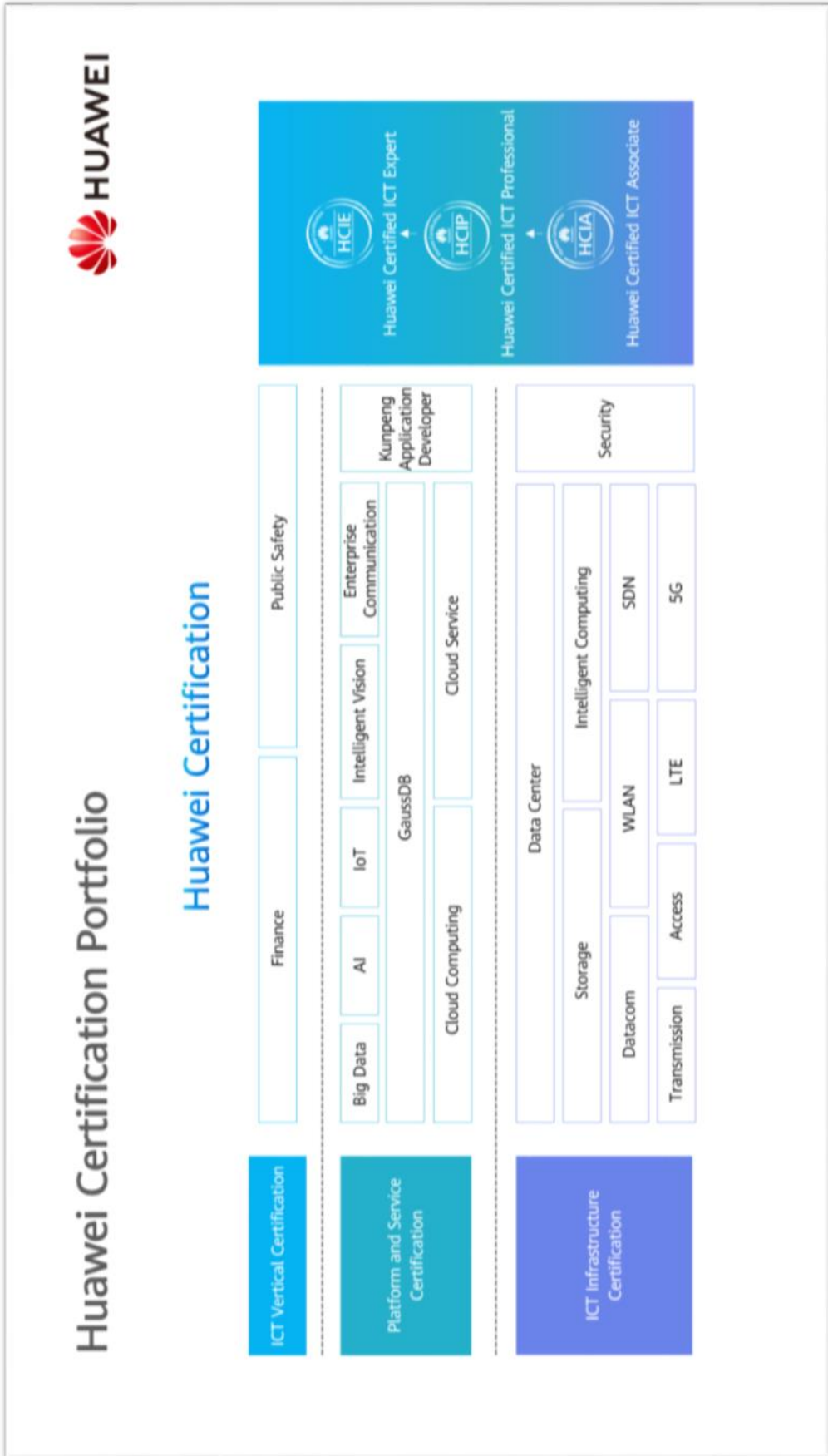

HCIA-Storage V4.5 Lab Course Overview

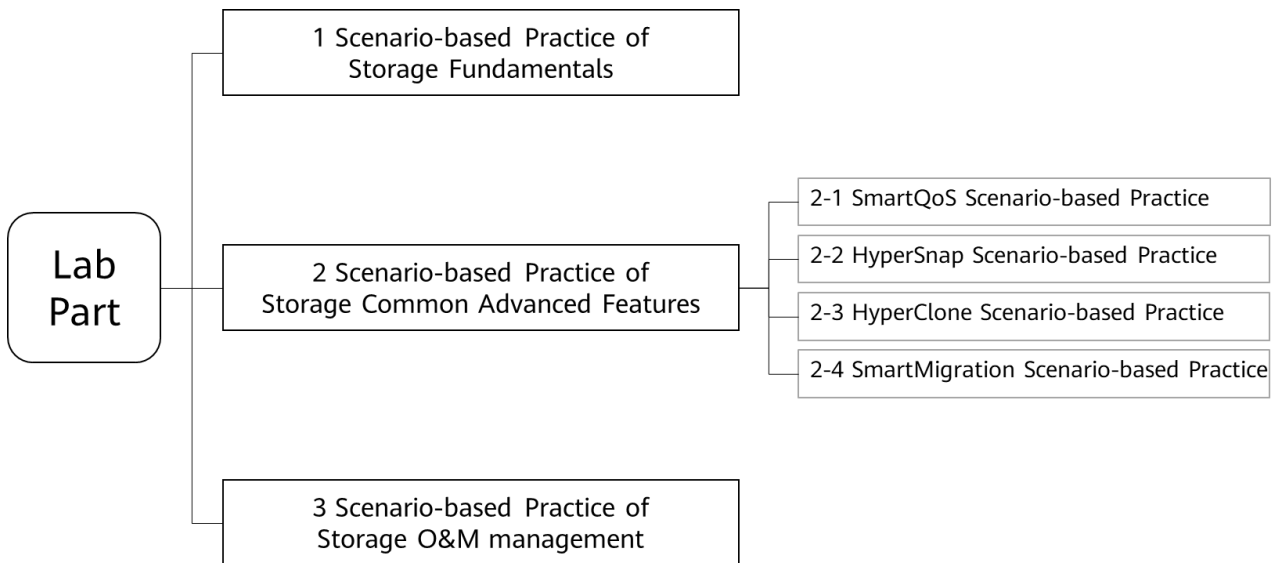

Scenario-based Practice of Storage Fundamentals



Background

- Company W needs a high-performance storage system to support new service lines. The planned upper-layer services are OLTP transactional databases. To meet service development requirements, company W purchases a Huawei OceanStor Dorado V6 storage system. To ensure proper service running, two test servers are used. Server A runs the Windows OS, server B runs the Linux OS, and storage devices provide block storage services for the two servers over an IP network.
- Help storage engineer A with network planning and design, initial configuration, and block service configuration.

Practice Mode

Objectives

- To be able to plan and design typical networks.
- To be able to complete initial configuration and basic service configuration and deployment of OceanStor Dorado storage systems.

Procedure

- Topic introduction
- Case study
- Scenario-based practice
- Presentation
- Evaluation and feedback

Opinion
Sharing

Form

- Two or three persons form a group.
- Each group prepares materials for presentation.
- After the presentation of each group, the technical officer asks questions, and the evaluator gives feedback and scores.

Assessment Criteria

- Accuracy
- Completeness
- Presentation
- Time control

Scenario 1: Requirement Analysis, Planning, and Design

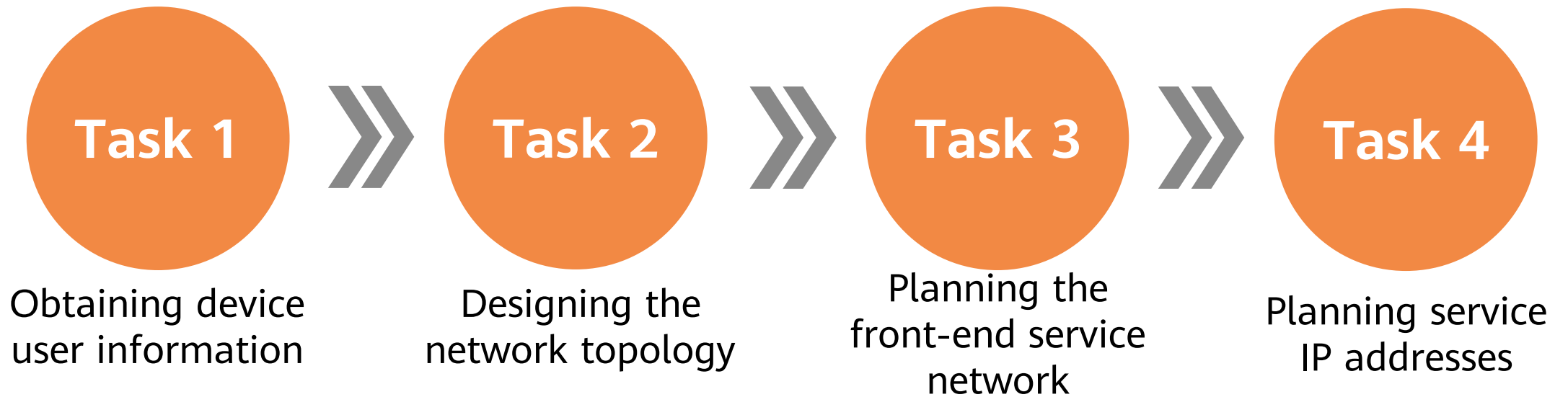

Question 1

- Please analyze the business requirements of company W.
- Suggested answer:
 - Storage devices provide block storage services for two servers over an IP network. The servers run the Windows and Linux OSs respectively.
 - Block storage services need to be configured through planning and design.

Question 2

- What needs to be done to meet the requirements of company W? (For example, what needs to be planned?)
- Suggested answer:
 - To ensure that the created storage resources meet service requirements, you need to properly plan them. The planning includes but is not limited to: network planning, network allocation, service IP address planning, usable capacity planning, storage pool planning, and LUN planning.

Question 3

- What are the common networking modes of storage service networks? How to prevent SPOFs?
- Suggested answer:
 - The networking modes include dual-switch networking, single-switch networking, and direct-connection networking.
 - Using dual-controller or multi-controller architecture, dual-switch networking, and server clusters can prevent SPOFs.

Task 1: Obtaining Device User Information

- Plan and record device user information.

Device Name	Management IP Address	Subnet Mask	Gateway	User Name	Password
Storage001					
Host001					
Host002					

Task 2: Designing the Network Topology

- Draw the service network topology for this scenario.



Linux host



Windows host



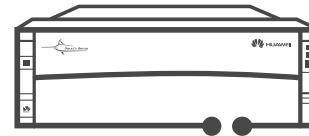

Ethernet switch



Huawei OceanStor
all-flash storage

Task 3: Planning the Front-End Service Network

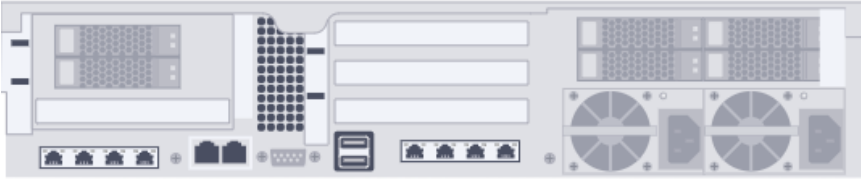
- Plan device connections for the front-end service network.

Device Name	Connection Diagram
IP_Switch001	 A network switch device with multiple ports on the front panel, including Ethernet and SFP ports.
Host001	 A server host with a keyboard, mouse, and network ports on the front panel.
Host002	 A server host with a keyboard, mouse, and network ports on the front panel.
Storage001	 A storage device with multiple drives and network ports on the front panel.

Task 4: Planning Service IP Addresses

- Plan front-end service IP addresses based on the network topology.

Device Name	Port Location	IP Address	Subnet Mask	Gateway
Storage001				
Host001				
Host002				

Scenario 2: Initial Configuration



Initial configuration

Question

- What information can be configured in the initial configuration wizard of the Huawei OceanStor all-flash storage system?
- Suggested answer:
 - Configure basic information (device information, device time, license, and alarm notification), create storage pools, scan for UltraPath hosts, and allocate storage resources.

Task 1: Initial Configuration

- Log in to DeviceManager and initialize the storage system in the initial configuration wizard.
- Configure basic information, create storage pools, and fill in the following form.

Basic Information	Result
Device name	
Device location	
Device time	
Storage pool name, capacity alarm threshold, and capacity exhaustion alarm threshold	

Scenario 3: Basic Service Planning and Configuration

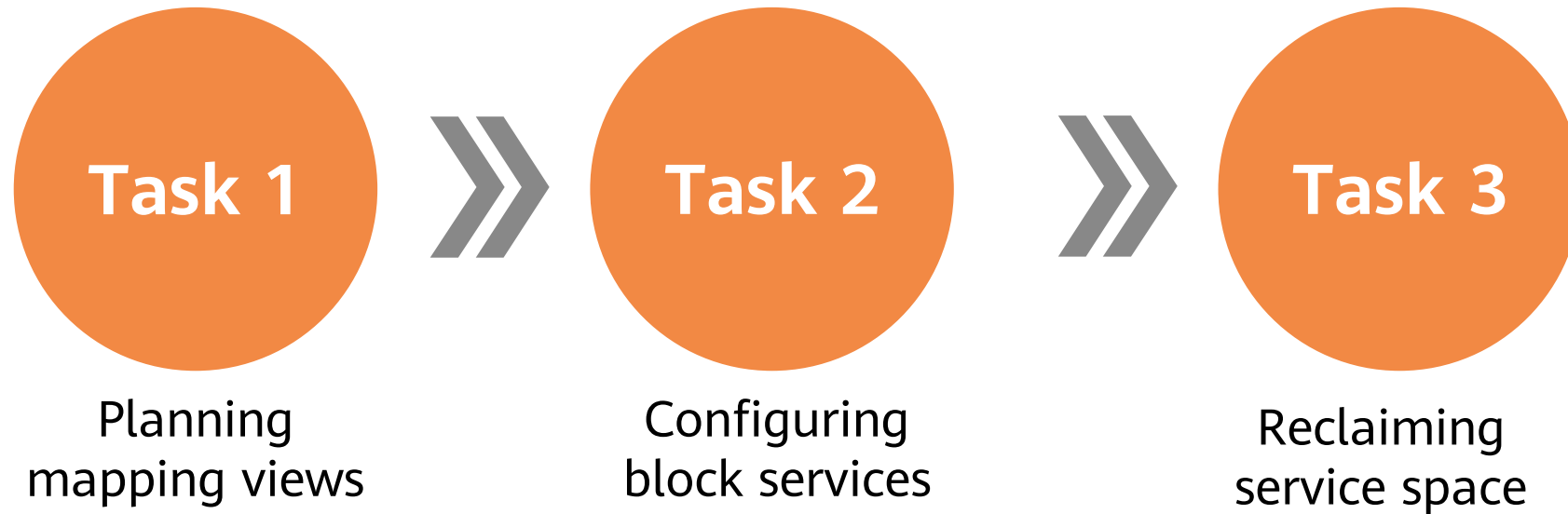

Question 1

- Planning storage capacity:

Storage Pool Name	Disk Type	Disk Quantity	Hot Spare Policy	RAID Policy
StoragePool001				
LUN Name	ID	Type	Capacity	/
LUN001				
LUN002				

- Suggested answer:

Storage Pool Name	Disk Type	Disk Quantity	Hot Spare Policy	RAID Policy
StoragePool001	SSD	10	Low (1 disk)	RAID 6
LUN Name	ID	Type	Capacity	/
LUN001	0	Thin	3.0 GB	
LUN002	1	Thin	5.0 GB	

Question 2

- What factors need to be considered during usable capacity planning?
- Suggested answer:
 - Differences between the nominal capacity of a single disk and the capacity displayed on the OS, hot spare capacity, and RAID usage. The evaluation results of eDesigner take precedence over the considerations.
- How many RAID levels does Huawei OceanStor Dorado support?
- Suggested answer:
 - RAID 5, RAID 6, and RAID-TP

Question 3

- Does Huawei OceanStor Dorado support thick LUNs?
- Suggested answer:
 - No

Task 1: Planning Mapping Views

- Plan mapping views.

Mapping View 1: to Windows Hosts					
LUN Name	Owning Storage Pool	LUN Capacity	Host Name	OS	IQN
Mapping View 2: to Linux Hosts					
LUN Name	Owning Storage Pool	LUN Capacity	Host Name	OS	IQN

Question

- What are the key steps in the configuration process?
- Suggested answer:

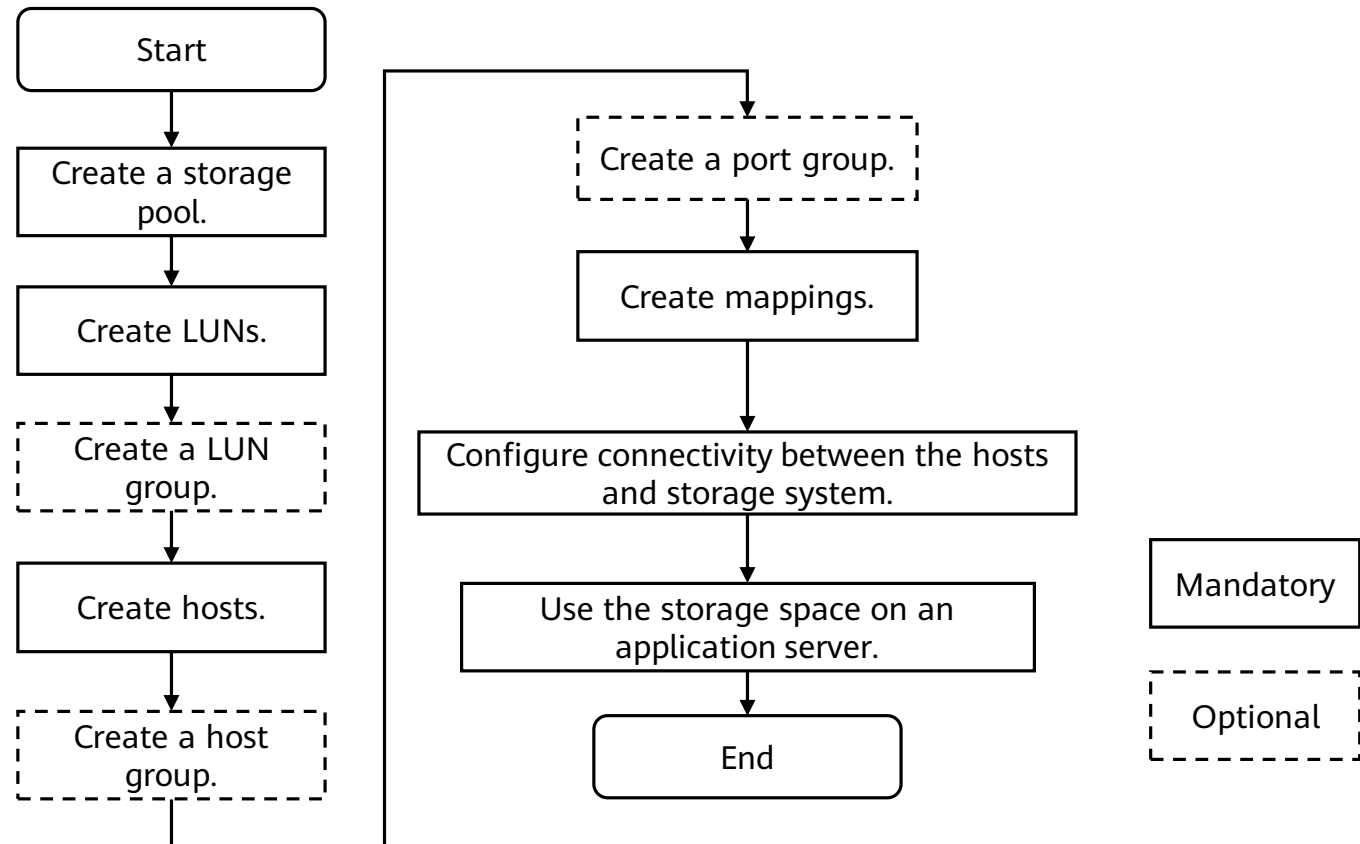

Task 2: Configuring Block Services

- Create a storage pool.
- Create LUNs.
- Create hosts.
- Create mappings.
- (Optional) Install UltraPath.
- Configure connectivity between hosts and the storage system.
- Use the storage space on an application server.

Question

- What are the key steps in the service space reclamation process?
- Suggested answer:

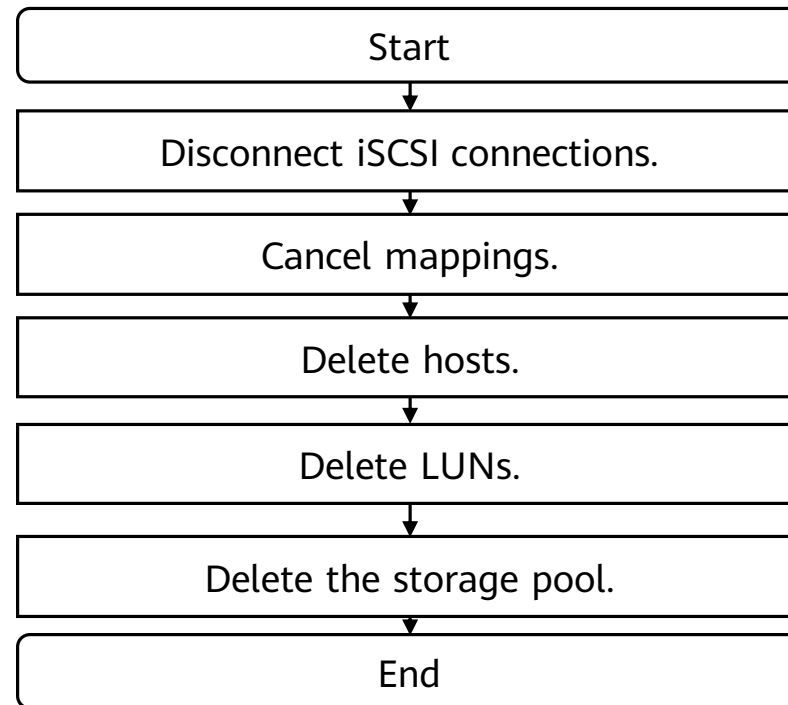

Task 3: Reclaiming Service Space

- Disconnect iSCSI connections.
- Cancel mappings.
- Delete hosts and initiators.
- Delete LUNs.
- Delete the storage pool.
- Perform acceptance tests.

Trainee Assessment

Item	Description	Score	Rating
Accuracy	The trainee's explanation is logical and fluent.	1 to 10	
Completeness	The answers presented by the trainee are complete.	1 to 20	
Presentation	The trainee presents answers clearly.	1 to 10	
Time control	The trainee provides the correct answers within the specified time.	1 to 10	
Overall		/	

Thank you.

把数字世界带入每个人、每个家庭、
每个组织，构建万物互联的智能世界。

Bring digital to every person, home, and
organization for a fully connected,
intelligent world.

**Copyright©2020 Huawei Technologies Co., Ltd.
All Rights Reserved.**

The information in this document may contain predictive statements including, without limitation, statements regarding the future financial and operating results, future product portfolio, new technology, etc. There are a number of factors that could cause actual results and developments to differ materially from those expressed or implied in the predictive statements. Therefore, such information is provided for reference purpose only and constitutes neither an offer nor an acceptance. Huawei may change the information at any time without notice.



Huawei Storage Certification Training

HCIA-Storage

Scenario-based Practice of Storage Fundamentals

(For Trainees)



HUAWEI

HUAWEI TECHNOLOGIES CO., LTD.

Copyright © Huawei Technologies Co., Ltd. 2020. All rights reserved.

No part of this document may be reproduced or transmitted in any form or by any means without prior written consent of Huawei Technologies Co., Ltd.

Trademarks and Permissions



and other Huawei trademarks are trademarks of Huawei Technologies Co., Ltd.

All other trademarks and trade names mentioned in this document are the property of their respective holders.

Notice

The purchased products, services and features are stipulated by the contract made between Huawei and the customer. All or part of the products, services and features described in this document may not be within the purchase scope or the usage scope. Unless otherwise specified in the contract, all statements, information, and recommendations in this document are provided "AS IS" without warranties, guarantees or representations of any kind, either express or implied.

The information in this document is subject to change without notice. Every effort has been made in the preparation of this document to ensure accuracy of the contents, but all statements, information, and recommendations in this document do not constitute a warranty of any kind, express or implied.

Huawei Technologies Co., Ltd.

Address: Huawei Industrial Base Bantian, Longgang Shenzhen 518129
People's Republic of China

Website: <http://e.huawei.com>



Huawei Certificate System

Huawei Certification follows the "platform + ecosystem" development strategy, which is a new collaborative architecture of ICT infrastructure based on "Cloud-Pipe-Terminal". Huawei has set up a complete certification system consisting of three categories: ICT infrastructure certification, Platform and Service certification and ICT vertical certification, and grants Huawei certification the only all-range technical certification in the industry.

Huawei offers three levels of certification: Huawei Certified ICT Associate (HCIA), Huawei Certified ICT Professional (HCIP), and Huawei Certified ICT Expert (HCIE).

Huawei Certified ICT Associate-Storage (HCIA-Storage) is designed for Huawei engineers, students and ICT industry personnel. HCIA-Storage covers knowledge about storage technology trends, storage basic technologies, storage common advanced technologies, storage business continuity solutions and storage system O&M management.

The HCIA-Storage certificate system introduces you to the industry and market, helps you in innovation, and enables you to stand atop the Storage frontiers.

Huawei Certification





Contents

1 References and Tools	4
1.1 References	4
1.2 Software Tools	4
1.3 Version Description	5
2 Scenario-based Practice of Storage Fundamentals	6
2.1 Course Overview	6
2.2 Objectives	6
2.3 Case Background	6
2.4 Tasks	7
Scenario 1: Requirement Analysis, Planning, and Design	7
Scenario 2: Initial Configuration	9
Scenario 3: Basic Service Planning and Configuration	10
2.5 Summary and Conclusion	17

1

References and Tools

1.1 References

Commands and documents listed in this document are for reference only. Use the corresponding commands and documents based on the product version in the actual environment.

Huawei OceanStor Dorado V6 Product Documentation

NOTE

Features supported by Huawei OceanStor Dorado vary with product models. For details, see the product documentation of the desired product model. You can log in to Huawei's technical support website (<https://support.huawei.com/enterprise/en/index.html>) and input the name of a document or tool in the search box to search for, browse, and download the desired document or tool.

1.2 Software Tools

1. Huawei OceanStor UltraPath

NOTE

You can log in to Huawei's technical support website (<https://support.huawei.com/enterprise/en/index.html>) and input UltraPath in the search box to search for, browse, and download the desired document or tool.

2. PuTTY

 NOTE

You are advised to use the open-source software PuTTY to log in to a terminal. You can use the common domain name (putty.org) of PuTTY to browse or download the desired document or tool.

1.3 Version Description

Name	Version	Quantity	Remarks
Storage system	Huawei OceanStor Dorado V6	1	Recommended version
Windows OS	Windows Server 2012 and Windows Server 2016	-	Recommended version
Linux OS	SUSE, Red Hat, CentOS, and EulerOS	-	Recommended version
S5700 switch	-	1	
Multipathing software	UltraPath 21.6.3	-	Recommended version

2 Scenario-based Practice of Storage Fundamentals

2.1 Course Overview

This course provides case study and scenario-based practices to help trainees consolidate their knowledge on initial configuration and basic service deployment and implementation of Huawei OceanStor storage.

2.2 Objectives

- To understand common networking modes of storage services
- To plan and design networks
- To complete the initial configuration of the storage system
- To install UltraPath
- To plan and configure block services

2.3 Case Background

NOTE

Cases in this document are examples only. The actual configurations may vary according to actual environments. For details, see the corresponding product document.

Company W needs a high-performance storage system to support new service lines. The planned upper-layer services are OLTP transactional databases. To meet service development requirements, company W purchases a Huawei OceanStor all-flash storage system. To ensure proper service running, two test servers are used. Server A runs the Windows OS, server B runs the Linux OS, and storage devices provide block storage services for the two servers over an IP network.

As a storage engineer, you are responsible for network planning and design, initial configuration, and block service configuration of the storage system.

2.4 Tasks

Scenario 1: Requirement Analysis, Planning, and Design

Background

As a storage engineer, how do you plan networks?

Question

1. Please analyze the business requirements of company W.

2. What needs to be done to meet the requirements of company W? (For example, what needs to be planned?)

[Suggested Procedure]

For details, see **Install and Upgrade > Installation Guide > Installation Planning** in the desired product documentation.

3. What are the common networking modes of storage service networks? How to prevent SPOFs?

[Suggested Procedure]

For details, see **Install and Upgrade > Installation Guide > Installation Planning** in the desired product documentation.

Task 1: Obtaining Device User Information

Plan and record the IP address and user information of the storage device based on the actual lab environment.

Device Name	Management IP Address	Subnet Mask	Gateway	User Name	Password
Storage001					
Host001					

Host002					
---------	--	--	--	--	--

[Suggested Procedure]

Follow certain principles when planning the IP address and user information of the storage device.

For details, see **Install and Upgrade > Installation Guide > Installation Planning** in the desired product documentation.

 **NOTE**

The following example is for reference only. The actual information may vary depending on lab environment.

Task 2: Designing the Network Topology

Draw the service network topology based on the case background.



Huawei OceanStor all-flash storage



Linux server



Ethernet switch



Windows server

[Suggested Procedure]



For details, see **Install and Upgrade > Installation Guide > Installation Planning** in the desired product documentation.

[Extension]

To ensure the security and stability of company W's services, use dual-switch networking to build the storage system. Draw the dual-switch networking topology.

Task 3: Planning the Front-End Service Network

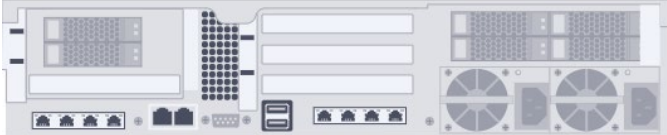
Plan the device connections of the front-end service network.

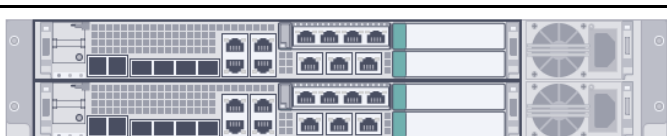
Device Name	Connection Diagram
IP_Switch001	
Host001	
Host002	
Storage001	

[Suggested Procedure]

For details, see Huawei Storage Networking Assistant (<https://support.huawei.com/onlinetoolsweb/sna/#/home>).

Task 4: Planning Service IP Addresses

Plan front-end service IP addresses based on the network topology.

Device Name	Port Location	IP Address	Subnet Mask	Gateway
Storage001				
Host001				
Host002				

NOTE

The following example is for reference only. The actual information may vary depending on lab environment.

[Suggested Procedure]

For details, see **Install and Upgrade > Installation Guide > Installation Planning** in the desired product documentation.

Scenario 2: Initial Configuration

Background

After the network planning and design are complete, perform initial configuration on the storage system.

Question

What information can be configured in the initial configuration wizard of the Huawei OceanStor all-flash storage system?

Task 1: Initial configuration

After logging in to DeviceManager, perform initial configuration on the storage system in the initial configuration wizard, including: configuring basic information, creating a storage pool (excluding scanning for UltraPath hosts and allocating storage resources), and filling in the following form.

NOTE

The initial configuration address is **https://XXX.XXX.XXX.XXX:8088/initialize**, where *XXX.XXX.XXX.XXX* indicates the IP address of the management network port of the storage system.

The following example is for reference only. The actual information may vary depending on lab environment.

Basic Information	Result
Device name	
Device location	
Device time	
Storage pool name, capacity alarm threshold, and capacity exhaustion alarm threshold	

[Suggested Procedure]

For details, see **Install and Upgrade > Initialization Guide > Logging In and Starting Initialization > Initially Configuring a Storage Device** in the desired product documentation.

NOTE

A license file is a credential for using basic storage features or value-added features. Before practices, check whether the license file is valid.

In this scenario, a license file has been imported and activated. You can manage the license in the initial configuration wizard.

Scenario 3: Basic Service Planning and Configuration

Background

After the tasks in scenarios 1 and 2 are complete, plan and configure block services.

Question

Plan the storage capacity and answer the following questions.

Storage Pool Name	Disk Type	Disk Quantity	Hot Spare Policy	RAID Policy
StoragePool001				
LUN Name	ID	Type	Capacity	/
LUN001				
LUN002				

1. What factors need to be considered during usable capacity planning?
2. How many RAID levels does Huawei OceanStor Dorado support?
3. Does Huawei OceanStor Dorado support thick LUNs?

[Suggested Procedure]

For details, see **Configure > Basic Storage Service Configuration Guide > Planning Basic Storage Services** in the desired product documentation.

NOTE

In this experiment environment, a single storage pool requires at least 8 normal member disks. If a storage pool spans multiple controller enclosures, the minimum number of disks required for creating the storage pool is calculated as follows: Minimum number of disks = 8 x Number of controller enclosures that the storage pool spans.

RAID 2.0+ allows all member disks in a storage pool to provide the hot spare capacity. For ease of understanding, the hot spare capacity is expressed in the number of hot spare disks on DeviceManager.

1. Differences between the nominal capacity of a single disk and the capacity displayed on the OS, hot spare capacity, and RAID usage. The evaluation results of eDesigner take precedence over the considerations of this section.
2. RAID 5, RAID 6, and RAID-TP
3. No

Task 1: Planning Mapping Views

Plan mapping views based on the case background.

Mapping View 1: to Windows Hosts					
LUN Name	Owning Storage Pool	LUN Capacity	Host Name	OS	IQN

Mapping View 2: to Linux Hosts					
LUN Name	Owning Storage Pool	LUN Capacity	Host Name	OS	IQN

Question

Provide key steps of the block service configuration process.

[Suggested Procedure]

For details, see **Configure > Basic Storage Service Configuration Guide > Configuring Basic Storage Services > Configuration Process** in the desired product documentation.

Task 2: Configuring Block Services

Based on the case background and planning, configure block services on the Windows and Linux servers. Then, use the storage space on the application server, that is, write a test file named **test.txt** to the application server.

Step 1 Create a storage pool.

To ensure that the application server can use the storage space of the storage system, create a storage pool named **StoragePool001**.

 **NOTE**

During initial configuration, if you have specified that all disks are used to create a unique storage pool, skip this step.

If this step is performed, the capacity of the storage pool depends on the actual planning and experiment environment.

[Suggested Procedure]

For details, see **Configure > Basic Storage Service Configuration Guide > Configuring Basic Storage Services > Creating a Storage Pool** in the desired product documentation.

Step 2 Create LUNs.

Create LUNs **LUN001** and **LUN002** and configure their capacities as planned.

[Suggested Procedure]

For details, see **Configure > Basic Storage Service Configuration Guide > Configuring Basic Storage Services > Creating a LUN** in the desired product documentation.

Step 3 Create hosts.

On DeviceManager, create virtual hosts **Host001** and **Host002** running Windows and Linux, respectively, for the storage system.



[Suggested Procedure]

For details, see **Configure > Basic Storage Service Configuration Guide > Configuring Basic Storage Services > Creating a Host** in the desired product documentation.

Step 4 Create mappings.

On DeviceManager, create mappings between the LUNs and hosts.



[Suggested Procedure]

For details, see **Configure > Basic Storage Service Configuration Guide > Configuring Basic Storage Services > Creating a Mapping** in the desired product documentation.

Step 5 (Optional) Install UltraPath.

 **NOTE**

OceanStor UltraPath is the multipathing software supported by Huawei, which is installed on servers to control the access of application servers to the storage system. UltraPath selects the paths for application servers to access the storage server and manages the paths.

This step is optional. You are advised to install UltraPath before deploying HyperMetro. If UltraPath is installed and configured after LUNs are mapped to an application server, you must restart the application server for the multipathing policies to take effect.

Install UltraPath on both the Windows and Linux hosts. (Obtain the UltraPath installation package from the trainer.)



[Suggested Procedure]

For details, see **Installing UltraPath** in the UltraPath user guide of the corresponding OS.

Step 6 Configure connectivity between hosts and the storage system.

1. Establish iSCSI connections.

Establish iSCSI connections between the Windows application server and storage system and between the Linux-based application server and storage system by complying the following configuration logic.

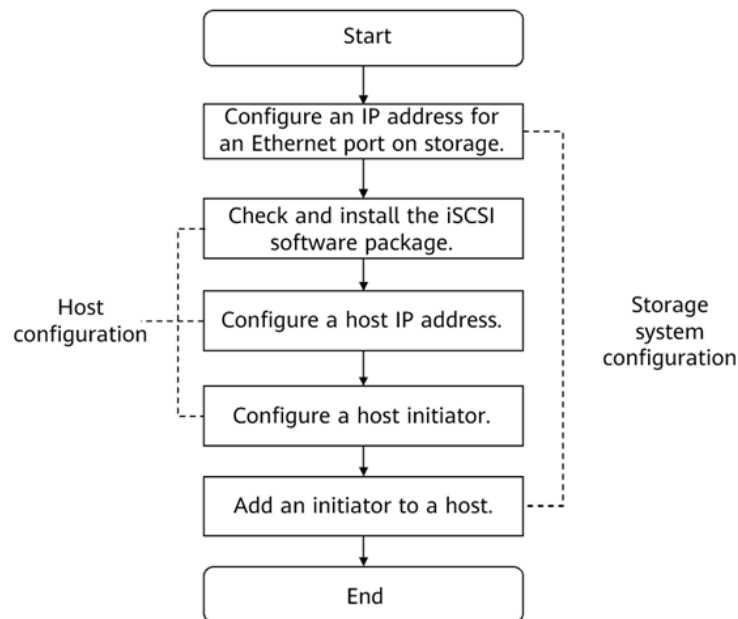

 **NOTE**

If switches are used, configure zones (for FC connections) or VLANs (for iSCSI connections) by referring to the official product documentation specific to the switch model and version.
The display of DeviceManager varies with different versions.

[Suggested Procedure]

For details, see **Configuring Connectivity > Establishing iSCSI Connections** in *OceanStor Dorado V6 Host Connectivity Guide for XXX*, where *XXX* indicates the OS, such as Windows, SUSE, Red Hat, CentOS, and EulerOS.

2. Scan LUNs on a host.

Scan for disks on the Windows and Linux servers respectively to detect LUNs mapped by the storage system.



[Suggested Procedure]

For details, see **Configuring Connectivity > Scanning LUNs on the Host** in *OceanStor Dorado V6 Host Connectivity Guide for XXX*, where *XXX* indicates the OS, such as Windows, SUSE, Red Hat, CentOS, and EulerOS.

Step 7 Use the storage space on an application server.

1. Manage volumes.

On the Windows and Linux servers, initialize, partition, and format the detected disks so that an application server can use the storage space.

[Suggested Procedure]

For details, see **Appendix A Volume Management** in *OceanStor Dorado V6 Host Connectivity Guide for XXX*, where *XXX* indicates the OS, such as Windows, SUSE, Red Hat, CentOS, and EulerOS.

2. Write a test file to verify the experiment result.

Write a test file to an application server to test whether the application server can properly use the storage space.

[Suggested Procedure]

For details, see **Appendix A Volume Management** in *OceanStor Dorado V6 Host Connectivity Guide for XXX*, where *XXX* indicates the OS, such as Windows, SUSE, Red Hat, CentOS, and EulerOS.

Question

Provide key steps of the service space reclamation process.

[Suggested Procedure]

For details, see **Configure > Basic Storage Service Configuration Guide > Managing Basic Storage Services** in the desired product documentation.

Task 3: Reclaiming Service Space

Step 1 Disconnect iSCSI connections.

Disconnect iSCSI connections from a service host.

[Suggested Procedure]

For details, see **Appendix A Volume Management** in *OceanStor Dorado V6 Host Connectivity Guide for XXX*, where *XXX* indicates the OS, such as Windows, SUSE, Red Hat, CentOS, and EulerOS.

Step 2 Delete mappings.

Log in to DeviceManager and cancel mappings between the hosts and LUNs.

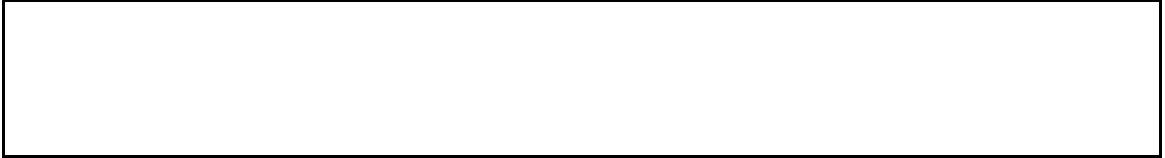

[Suggested Procedure]

For details, see **Configure > Basic Storage Service Configuration Guide > Managing Basic Storage Services > Managing Hosts** in the desired product documentation.

Step 3 Delete the hosts and initiators.

Log in to DeviceManager and delete the hosts, initiators, and service IP addresses.



[Suggested Procedure]

For details, see **Configure > Basic Storage Service Configuration Guide > Managing Basic Storage Services** in the desired product documentation.

Step 4 Delete LUNs.

Log in to DeviceManager and delete the LUNs to release storage space.



[Suggested Procedure]

For details, see **Configure > Basic Storage Service Configuration Guide > Managing Basic Storage Services > Managing LUNs** in the desired product documentation.

Step 5 Delete the storage pool.

Log in to DeviceManager and delete the storage pool.



[Suggested Procedure]

For details, see **Configure > Basic Storage Service Configuration Guide > Managing Basic Storage Services > Managing Storage Pools** in the desired product documentation.

Step 6 Verify the result.

Verify that the service space has been reclaimed successfully.

2.5 Summary and Conclusion

My Opinion:

Scenario-based Practice on SmartQoS

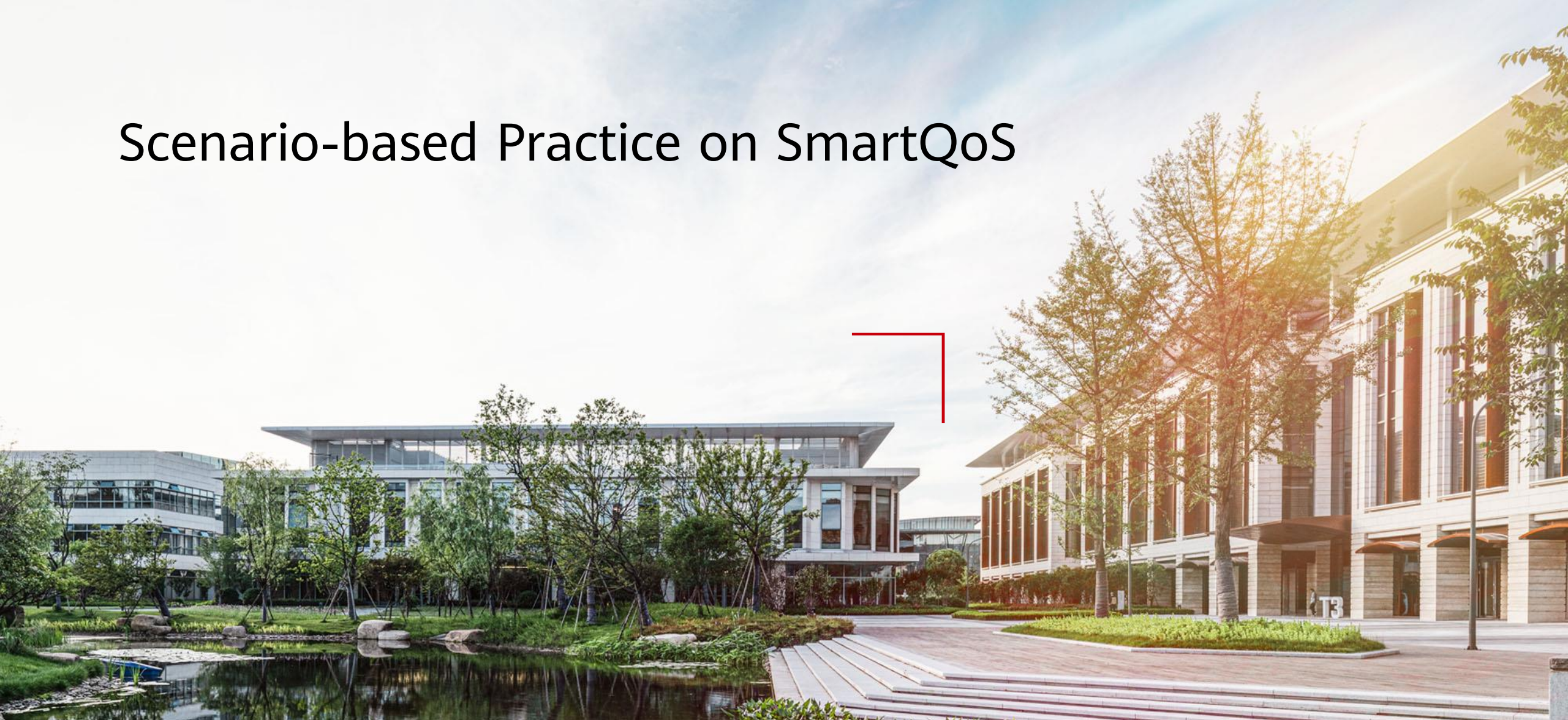

Background

- A company uses a Huawei OceanStor all-flash storage device to run services. Multiple LUNs have been created to support different services. LUN_0 mapped to the Linux service host carries critical services, and LUN_1 and LUN_2 mapped to the Windows host carry non-critical services. To ensure that LUN_0 can obtain storage resources preferentially, the company purchases SmartQoS.

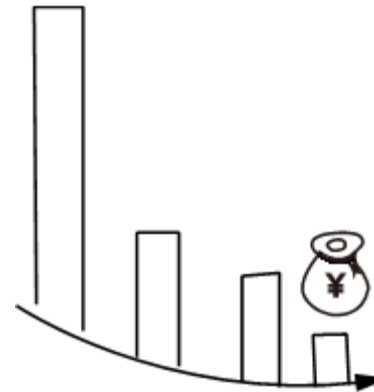

- **Note:** Cases in this course are examples only. The actual configurations may vary according to actual environments. For details, see the corresponding product documentation.

Networking Diagram

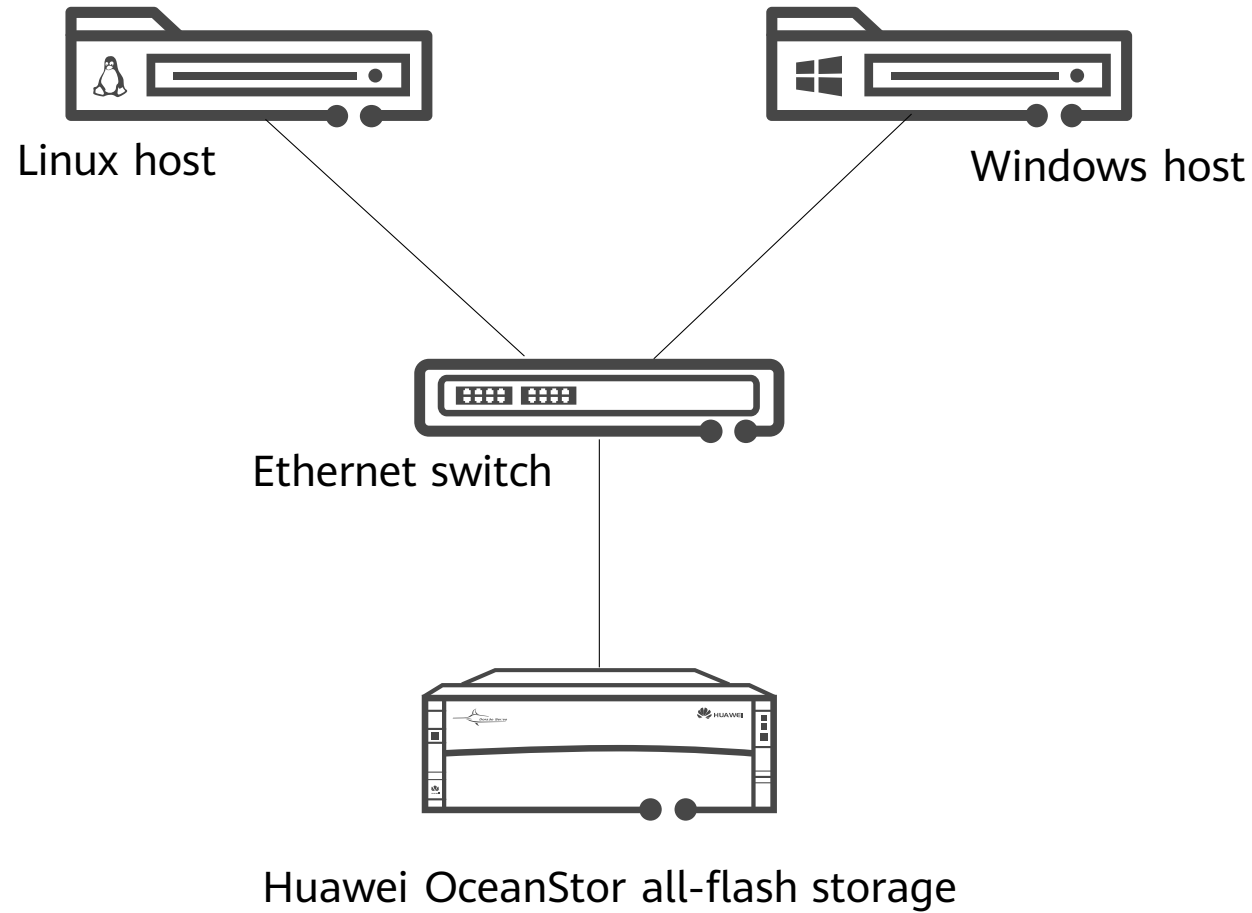

Practice Mode

Objectives

- To know the application scenarios of SmartQoS.
- To be able to configure SmartQoS.

Procedure

- Topic introduction
- Case study
- Scenario-based practice
- Presentation
- Evaluation and feedback

Opinion
Sharing

Form

- Two or three persons form a group.
- Each group prepares materials for presentation.
- After the presentation of each group, the technical officer asks questions, and the evaluator gives feedback and scores.

Assessment Criteria

- Accuracy
- Completeness
- Presentation
- Time control

Scenario-based Practice

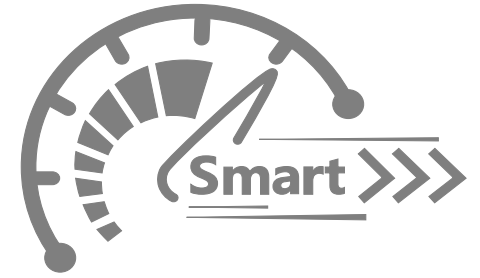
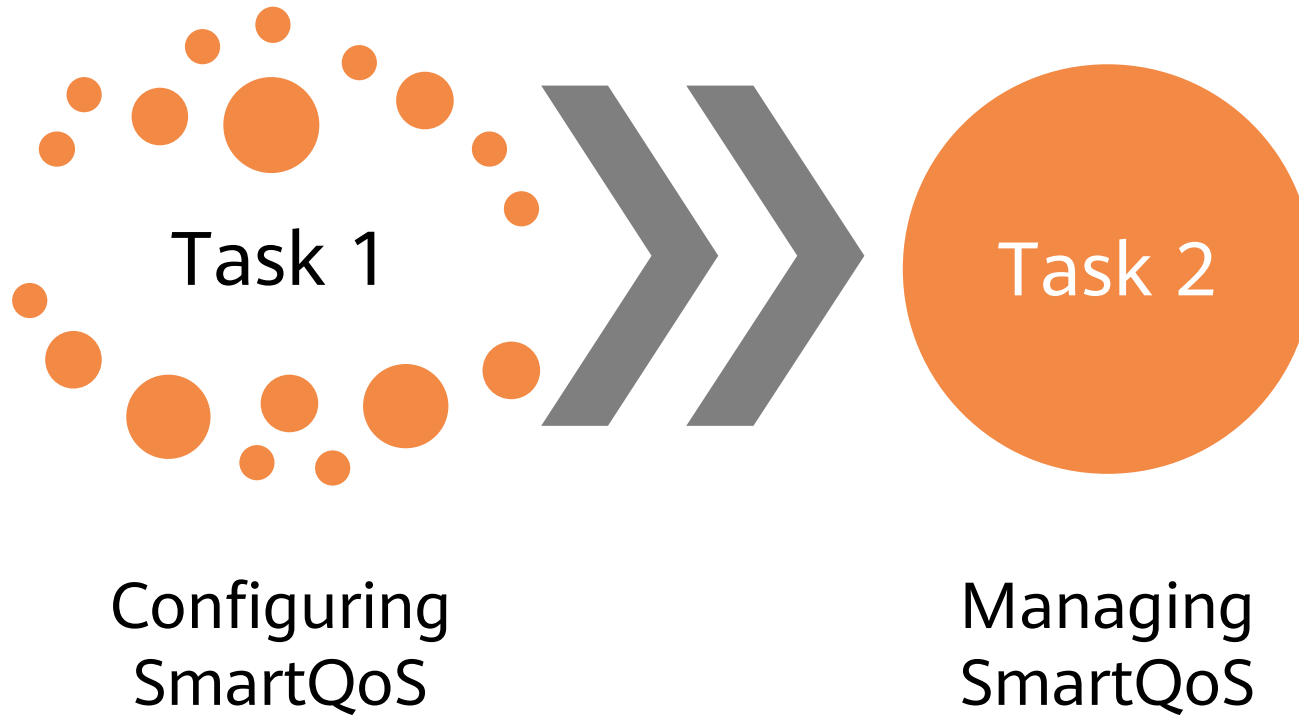

Question

- How to set indicators (bandwidth and IOPS) to implement traffic control?
- Suggested answer:
 - You can set either or both of **Bandwidth (MB/s)** and **Normalized IOPS (8 KB)**. You are advised to set only **Bandwidth (MB/s)** for bandwidth-intensive services and only **Normalized IOPS (8 KB)** for IOPS-intensive services. If you cannot determine the service type or the service type changes frequently, you can set both indicators and the system will control the traffic using the indicator with a smaller value.

Task 1: Configuring SmartQoS

- Draw a flowchart for configuring SmartQoS.
- View SmartQoS license information.
- Monitor service performance.
- Create a SmartQoS policy.

Question

- Why can the SmartQoS policy be adjusted based on the performance data of LUNs?
- Suggested answer:
 - Application data is stored on objects. By viewing the performance of the objects, users can learn about the usage of system resources by applications. According to service plans, users can determine whether application performance during a specified period of time is below or above preset objectives.
 - If the performance of an application is below the preset objectives, users can set SmartQoS policies to limit the performance of other applications, thereby reserving sufficient resources for this application.
 - If the performance of an application is above the preset objectives, users can set a SmartQoS policy to limit the performance of this application, thereby reserving sufficient resources for other applications.

Task 2: Managing SmartQoS

- Add an object.
- Remove an object.
- Activate and deactivate a SmartQoS policy.
- Modify a SmartQoS policy.
- Delete a SmartQoS policy.

Discussion

- In a storage system, what are the performance indicators and their applicable scenarios?
- Suggested answer:
 - IOPS: This indicator is applicable for online transaction processing (OLTP) services and SPC-1 authentication.
 - Bandwidth: This indicator is applicable for OLAP, media asset, and video surveillance services.
 - Latency: This indicator includes the average response time and maximum response time. For example, the latency of OLTP services must be less than 10 ms and that for the virtual desktop infrastructure (VDI) scenario must be less than 30 ms. The requirements on the latency of video on demand (VOD) and video surveillance services vary with bit rates.

Trainee Assessment

Item	Description	Score	Rating
Accuracy	The trainee's explanation is logical and fluent.	1 to 10	
Completeness	The answers presented by the trainee are complete.	1 to 20	
Presentation	The trainee presents answers clearly.	1 to 10	
Time control	The trainee provides the correct answers within the specified time.	1 to 10	
Overall		/	

Thank you.

把数字世界带入每个人、每个家庭、
每个组织，构建万物互联的智能世界。

Bring digital to every person, home, and
organization for a fully connected,
intelligent world.

**Copyright©2020 Huawei Technologies Co., Ltd.
All Rights Reserved.**

The information in this document may contain predictive statements including, without limitation, statements regarding the future financial and operating results, future product portfolio, new technology, etc. There are a number of factors that could cause actual results and developments to differ materially from those expressed or implied in the predictive statements. Therefore, such information is provided for reference purpose only and constitutes neither an offer nor an acceptance. Huawei may change the information at any time without notice.



Huawei Storage Certification Training

HCIA-Storage SmartQoS Scenario-based Practice

(For Trainees)



HUAWEI

HUAWEI TECHNOLOGIES CO., LTD.

Copyright © Huawei Technologies Co., Ltd. 2020. All rights reserved.

No part of this document may be reproduced or transmitted in any form or by any means without prior written consent of Huawei Technologies Co., Ltd.

Trademarks and Permissions



and other Huawei trademarks are trademarks of Huawei Technologies Co., Ltd.

All other trademarks and trade names mentioned in this document are the property of their respective holders.

Notice

The purchased products, services and features are stipulated by the contract made between Huawei and the customer. All or part of the products, services and features described in this document may not be within the purchase scope or the usage scope. Unless otherwise specified in the contract, all statements, information, and recommendations in this document are provided "AS IS" without warranties, guarantees or representations of any kind, either express or implied.

The information in this document is subject to change without notice. Every effort has been made in the preparation of this document to ensure accuracy of the contents, but all statements, information, and recommendations in this document do not constitute a warranty of any kind, express or implied.

Huawei Technologies Co., Ltd.

Address: Huawei Industrial Base Bantian, Longgang Shenzhen 518129
People's Republic of China

Website: <http://e.huawei.com>

Huawei Certificate System

Huawei Certification follows the "platform + ecosystem" development strategy, which is a new collaborative architecture of ICT infrastructure based on "Cloud-Pipe-Terminal". Huawei has set up a complete certification system consisting of three categories: ICT infrastructure certification, Platform and Service certification and ICT vertical certification, and grants Huawei certification the only all-range technical certification in the industry.

Huawei offers three levels of certification: Huawei Certified ICT Associate (HCIA), Huawei Certified ICT Professional (HCIP), and Huawei Certified ICT Expert (HCIE).

Huawei Certified ICT Associate-Storage (HCIA-Storage) is designed for Huawei engineers, students and ICT industry personnel. HCIA-Storage covers knowledge about storage technology trends, storage basic technologies, storage common advanced technologies, storage business continuity solutions and storage system O&M management.

The HCIA-Storage certificate system introduces you to the industry and market, helps you in innovation, and enables you to stand atop the Storage frontiers.

Huawei Certification





Contents

1 References and Tools	4
1.1 References	4
1.2 Software Tools	4
1.3 Version Description	4
2 Scenario-based Practice on SmartQoS.....	5
2.1 Course Overview	5
2.2 Objectives	5
2.3 Case Background	5
2.4 Tasks.....	6
2.4.1 Scenario: Using SmartQoS	6
2.5 Summary and Conclusion	10

1 References and Tools

1.1 References

The commands, documents, and document paths listed in this document are for reference only. The actual commands, documents, and document paths may vary.

Huawei OceanStor Dorado V6 Product Documentation

 **NOTE**

The specifications of SmartQoS vary with products. For details, see the product documentation of the desired product model. You can log in to Huawei's technical support website (<https://support.huawei.com/enterprise/>) and input the name of a document or tool in the search box to search for, browse, and download the desired document or tool.

1.2 Software Tools

PuTTY

 **NOTE**

You are advised to use the open-source software PuTTY to log in to a terminal. You can use the common domain name (putty.org) of PuTTY to browse or download the desired document or tool.

1.3 Version Description

Name	Version	Quantity	Remarks
Storage device	Huawei OceanStor Dorado V6	1	
Windows OS	Windows Server 2012, Windows Server 2016	--	Recommended version
Linux OS	SUSE, Red Hat, CentOS, EulerOS	--	Recommended version

2 Scenario-based Practice on SmartQoS

2.1 Course Overview

This course provides case study and scenario-based practices to help trainees consolidate their knowledge on the use of SmartQoS. SmartQoS is a common advanced storage technology. Before using SmartQoS, you are advised to learn how to configure basic storage services.

2.2 Objectives

- To know the application scenarios of SmartQoS
- To be able to configure SmartQoS

2.3 Case Background

NOTE

Cases in this document are examples only. The actual configurations may vary according to actual environments. For details, see the corresponding product document. The names of storage pools and LUNs involved in this document can be customized (for example, LUN_XXX) for different trainees if they use the same device.

A company uses a Huawei OceanStor all-flash storage device to run services. Multiple LUNs have been created to support different services. LUN_0 mapped to the Linux service host carries critical services, and LUN_1 and LUN_2 mapped to the Windows host carry non-critical services. To ensure that LUN_0 can obtain storage resources preferentially, the company purchases SmartQoS. Help storage engineers get familiar with operations related to SmartQoS.

The following figure shows the live network topology of the enterprise.

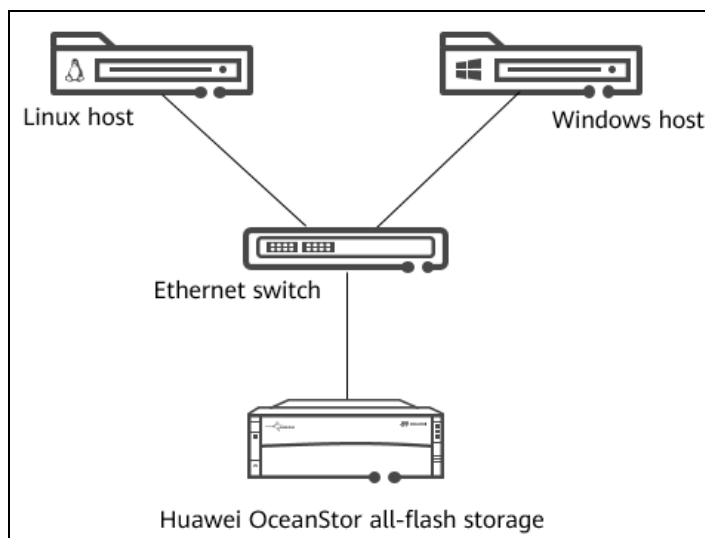

Figure 2-1 Network topology

2.4 Tasks

2.4.1 Scenario: Using SmartQoS

Background

SmartQoS is configured to accurately limit the performance of applications and prevent non-critical applications from contending for too many storage resources.

Question

How do we set indicators (bandwidth and IOPS) to implement traffic control?

Task 1: Configuring SmartQoS

Help the engineer configure SmartQoS.

Step 1 Draw a flowchart for configuring SmartQoS.

Demonstrate how to configure SmartQoS.

[Suggested Procedure]

For details about how to draw a flowchart, see **Configure > SmartQoS Feature Guide > Configuring SmartQoS > Configuration Process** in the product documentation.

Step 2 View SmartQoS license information.

Before configuring SmartQoS, ensure that the permission for using SmartQoS has been granted. Help the engineer check SmartQoS license information.



[Suggested Procedure]

For details about operations on DeviceManager, see **Configure > SmartQoS Feature Guide > Configuring SmartQoS > Checking the SmartQoS License** in the product documentation.

For details about operations on the CLI, see **Reference > Command Reference > License Management Commands > license > show license** in the product documentation.

For details about how to log in to the CLI of the storage system, see **Reference > Advanced O&M Command Reference > CLI Use Guidance > Logging In to the CLI of the Storage System** in the product documentation.

Step 3 Monitor service performance.

Obtain the I/O characteristics of LUNs by using the service monitoring function of storage systems and use these characteristics as a basis of SmartQoS policies. View the total IOPS of LUNs.

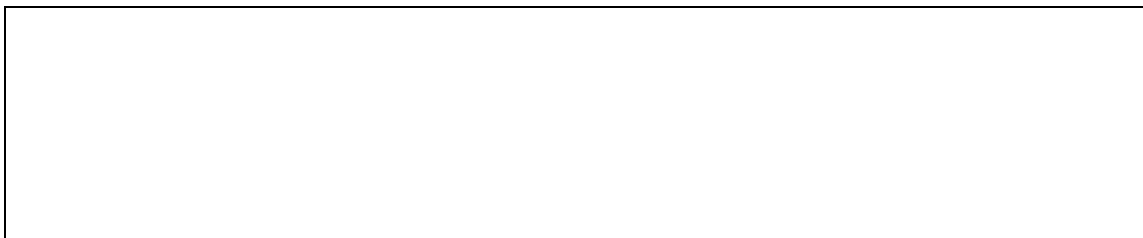

[Suggested Procedure]

For details about operations on DeviceManager, see **Configure > SmartQoS Feature Guide > Configuring SmartQoS > Monitoring Application Performance** in the product documentation.

Step 4 Create a SmartQoS policy.

After analyzing the performance monitoring data, the engineer concludes that the IOPS of **LUN_1** should be within 200. Help the engineer configure SmartQoS policy **Policy01** to set the maximum IOPS to 200.

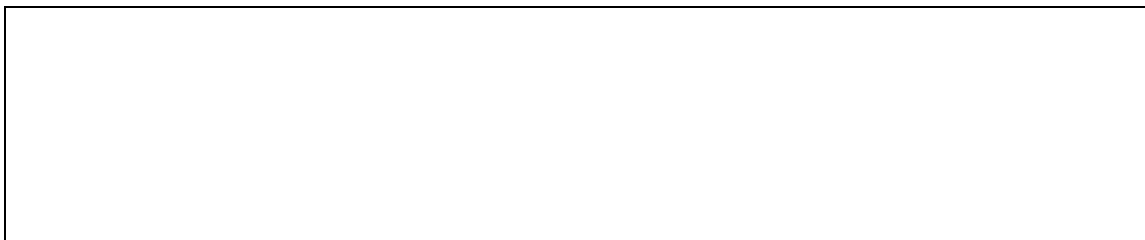

[Suggested Procedure]

For details about operations on DeviceManager, see **Configure > SmartQoS Feature Guide > Configuring SmartQoS > Creating a SmartQoS Policy** in the product documentation.

Question

Why can the SmartQoS policy be adjusted based on the performance data of LUNs?

Task 2: Managing SmartQoS

After configuring SmartQoS, the engineer needs to manage SmartQoS to adjust data flows, thereby properly allocating storage resources. Explain to the engineer how to manage SmartQoS.

Step 1 Add a control object.

On DeviceManager, you can add new control objects to the SmartQoS policy as required. Add control object **LUN_2** to **Policy01**.

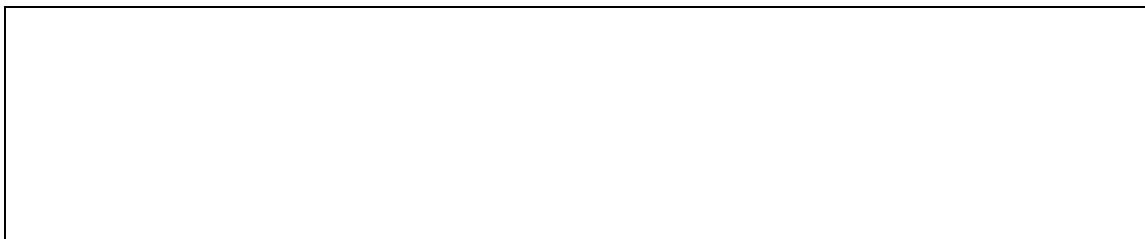

[Suggested Procedure]

For details about operations on DeviceManager, see **Configure > SmartQoS Feature Guide > Managing SmartQoS > Adding a Control Object** in the product documentation.

Step 2 Remove a control object.

On DeviceManager, you can remove control objects from a SmartQoS policy as required. Remove control object **LUN_2** from **Policy01**.



[Suggested Procedure]

For details about operations on DeviceManager, see **Configure > SmartQoS Feature Guide > Managing SmartQoS > Removing a Control Object** in the product documentation.

Step 3 Activate and deactivate a SmartQoS policy.

A SmartQoS policy can take effect according to its triggering policy after it is activated. In a storage system where only one type of applications is available or all LUNs or LUN groups need the same amount of resources, you can deactivate SmartQoS policies because adjusting and controlling performance of I/O classes is unnecessary. Help the engineer get familiar with the activation and deactivation of **Policy01**.

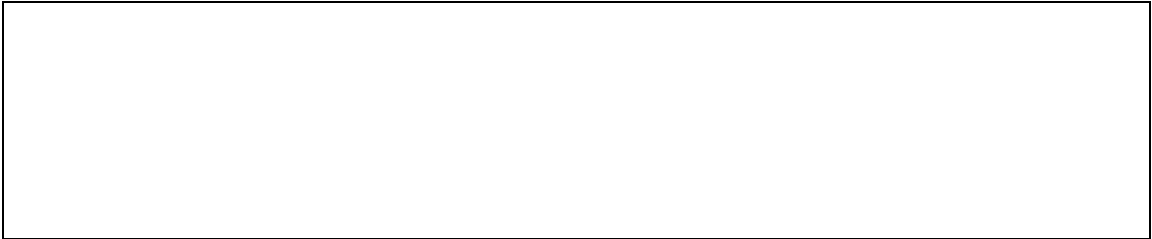

[Suggested Procedure]

For details about operations on DeviceManager, see **Configure > SmartQoS Feature Guide > Managing SmartQoS > Activating Creating a SmartQoS Policy and Deactivating a SmartQoS Policy** in the product documentation.

Step 4 Modify a SmartQoS policy.

In off-peak hours, the engineer considers that the IOPS limit for non-critical services can be adjusted to 300. Help the engineer change the maximum IOPS limit to 300 for **Policy01**.



[Suggested Procedure]

For details about operations on DeviceManager, see **Configure > SmartQoS Feature Guide > Managing SmartQoS > Modifying a SmartQoS Policy** in the product documentation.

Step 5 Delete a SmartQoS policy.

As the company develops, critical services are migrated to other storage devices and do not need to compete for resources with non-critical services. Therefore, the original SmartQoS policy can be deleted. Help the engineer delete SmartQoS policy **Policy01**.

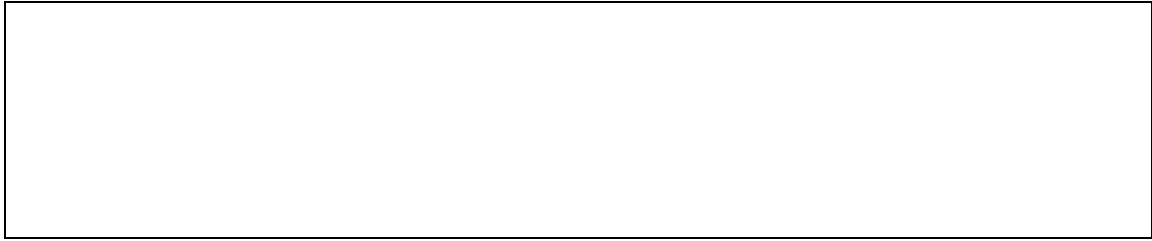

[Suggested Procedure]

For details about operations on DeviceManager, see **Configure > SmartQoS Feature Guide > Managing SmartQoS > Deleting a SmartQoS Policy** in the product documentation.

Discussion

In a storage system, what are the performance indicators and their applicable scenarios?

2.5 Summary and Conclusion

My Opinion:

Scenario-based Practice on HyperSnap

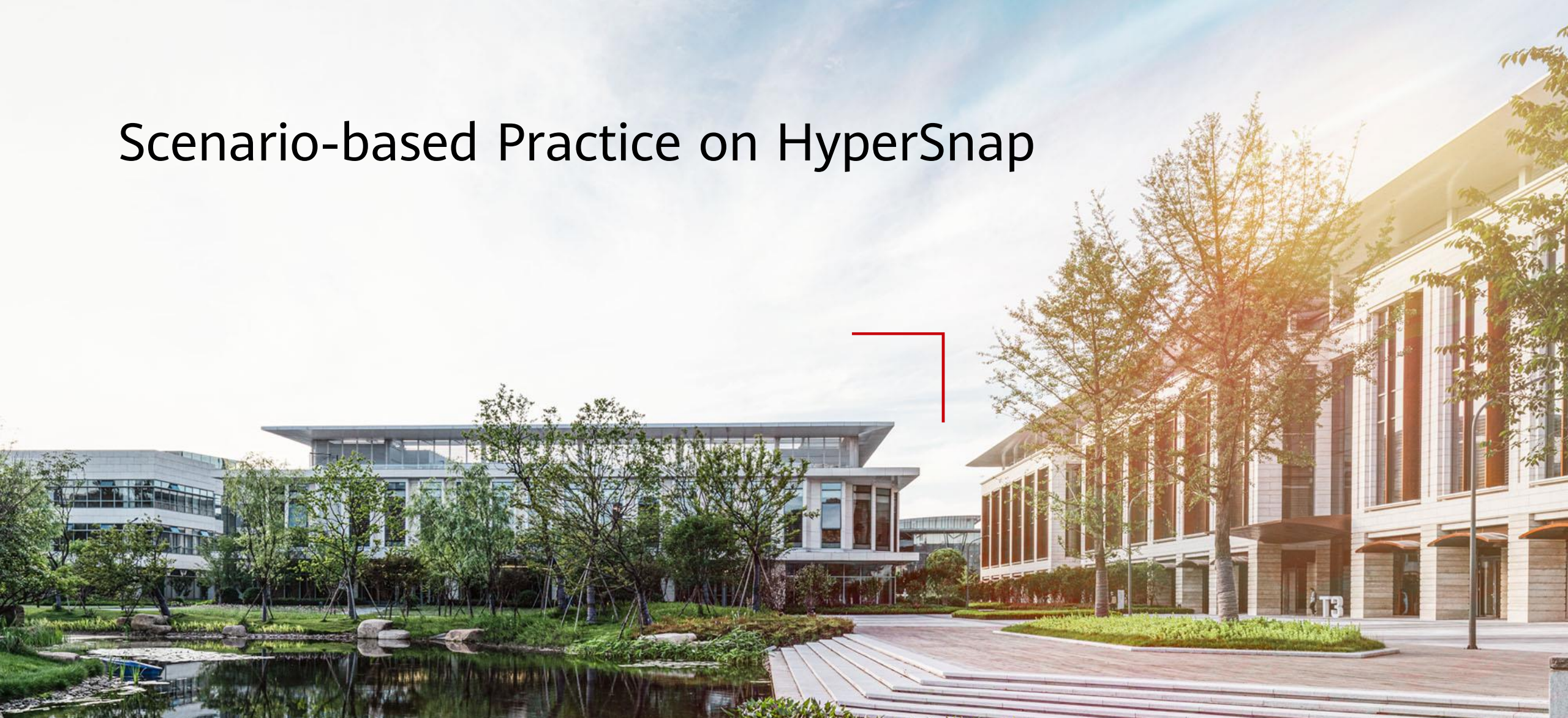

Case Background

- An enterprise has an OceanStor all-flash storage device. To shorten the backup window, the enterprise purchased HyperSnap. Help storage engineers get familiar with operations related to HyperSnap.

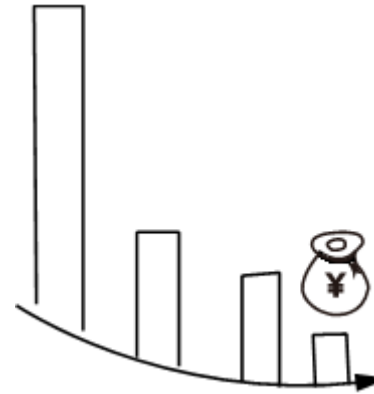

- **Note:** Cases in this course are examples only. The actual configurations may vary according to actual environments. For details, see the corresponding product documentation.

Networking Diagram

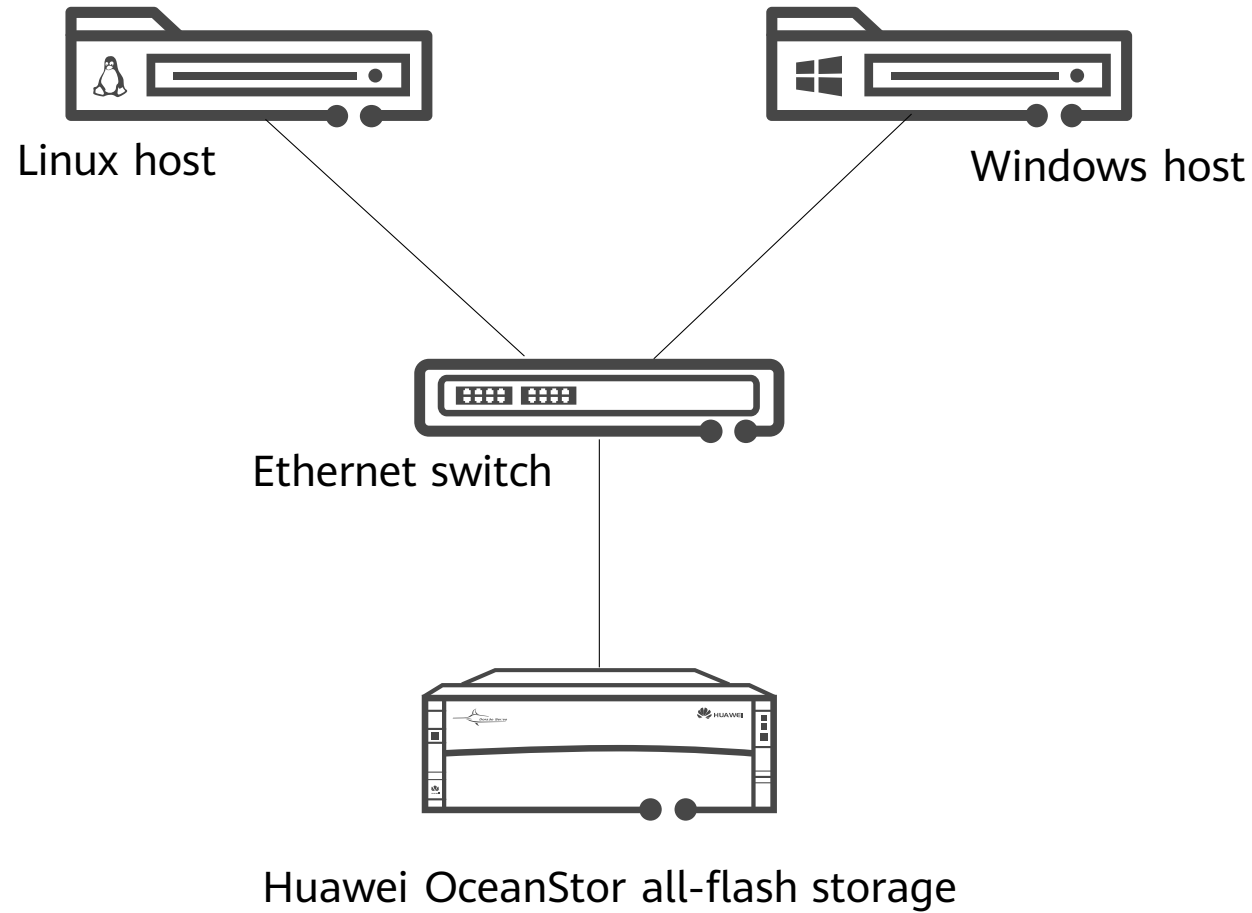

Practice Mode

Objectives

- To be able to configure a snapshot of a LUN.
- To understand how to roll back data using a snapshot.

Procedure

- Topic introduction
- Case study
- Scenario-based practice
- Presentation
- Evaluation and feedback

Opinion
Sharing

Form

- Two or three persons form a group.
- Each group prepares materials for presentation.
- After the presentation of each group, the technical officer asks questions, and the evaluator gives feedback and scores.

Assessment Criteria

- Accuracy
- Completeness
- Presentation
- Time control

Scenario-based Practice

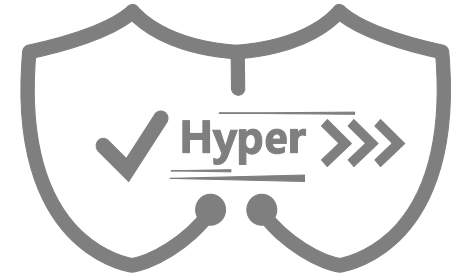
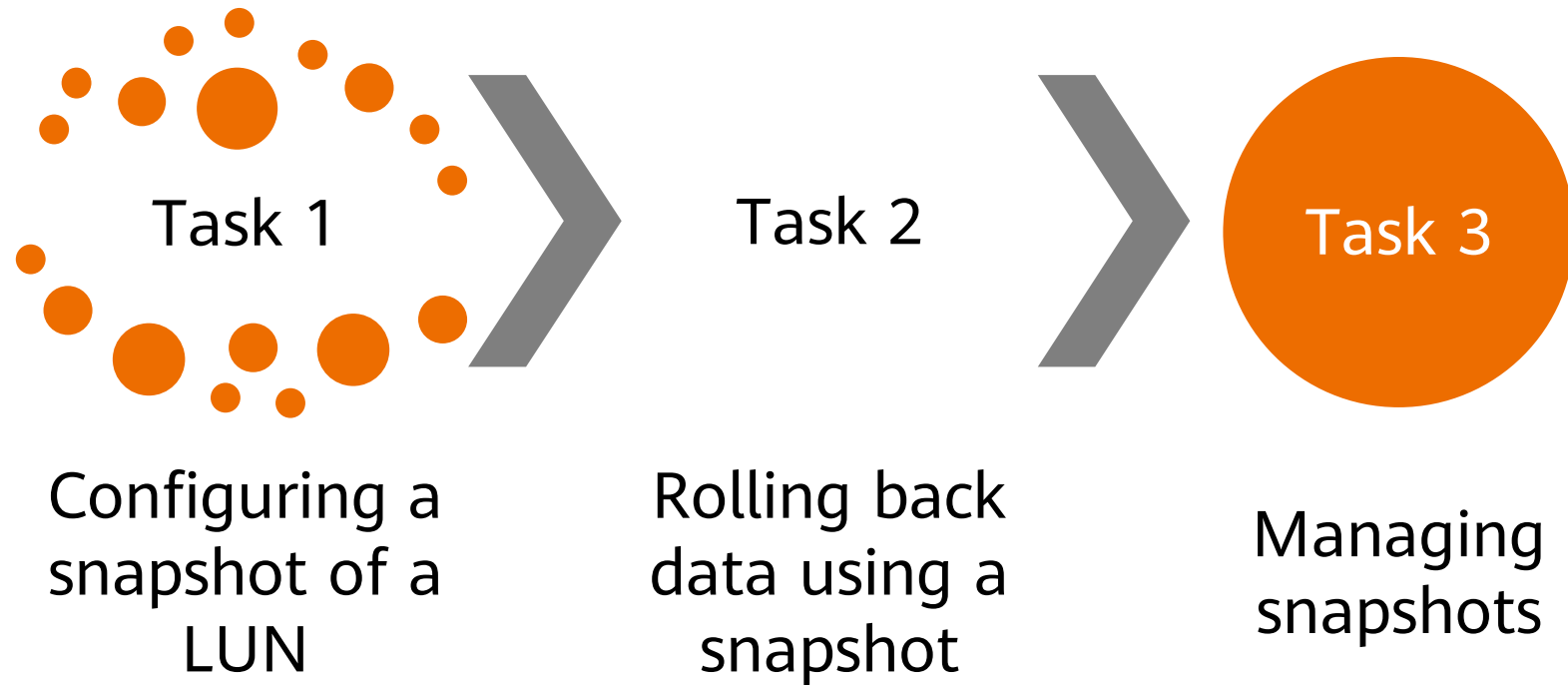

Question

- What are COW and ROW?
- Suggested answer:
 - A snapshot can be implemented using the copy-on-write (COW) or redirect-on-write (ROW) technology.
 - COW enables data to be copied in the initial data write process. Data copy affects write performance of hosts.
 - ROW does not involve data copy. However, after data is overwritten frequently, data distribution on the source LUN will be damaged, adversely affecting sequential read performance of hosts.

Task 1: Configuring a Snapshot of a LUN

- Draw a flowchart for configuring HyperSnap.
- View HyperSnap license information.
- Create a snapshot.

Question

- Why can a snapshot of a LUN be used to recover data without saving all copies of the source LUN?
- Suggested answer:
 - COW is performed before data is written to the source LUN. Before data is modified, it is saved to the COW shared space. Therefore, only the modified data in the COW space needs to be restored.

Task 2: Rolling Back Data Using a Snapshot

- Check the snapshot status.
- Cancel the mapping between the source LUN and the host.
- Roll back data using a snapshot.

Question

- For a writable snapshot, if data on the snapshot LUN is modified, can the snapshot LUN be used to restore data on the source LUN?
- Suggested answer:
 - No. However, multiple copies can be created for the snapshot LUN. If data on the snapshot LUN is modified, these copies can be used to restore data on the source LUN.

Task 3: Managing Snapshots

- Modify a snapshot.
- Delete a snapshot.

Discussion

- Why can the Huawei OceanStor all-flash storage system implement lossless performance using the ROW technology?
- Suggested answer:
 - Due to the limitations of HDDs, the COW technology used on traditional storage systems affects the write performance of hosts. Independent storage systems or devices composed of solid-state storage media have great advantages in random read and write. OceanStor Dorado V6 all-flash storage systems use the ROW technology to implement lossless performance without using the COW technology.

Trainee Assessment

Item	Description	Score	Rating
Accuracy	The trainee's explanation is logical and fluent.	1 to 10	
Completeness	The answers presented by the trainee are complete.	1 to 20	
Presentation	The trainee presents answers clearly.	1 to 10	
Time control	The trainee provides the correct answers within the specified time.	1 to 10	
Overall		/	

Thank you.

把数字世界带入每个人、每个家庭、
每个组织，构建万物互联的智能世界。

Bring digital to every person, home, and
organization for a fully connected,
intelligent world.

**Copyright©2020 Huawei Technologies Co., Ltd.
All Rights Reserved.**

The information in this document may contain predictive statements including, without limitation, statements regarding the future financial and operating results, future product portfolio, new technology, etc. There are a number of factors that could cause actual results and developments to differ materially from those expressed or implied in the predictive statements. Therefore, such information is provided for reference purpose only and constitutes neither an offer nor an acceptance. Huawei may change the information at any time without notice.



Huawei Storage Certification Training

HCIA-Storage HyperSnap Scenario-based Practice

(For Trainees)



HUAWEI

HUAWEI TECHNOLOGIES CO., LTD.

Copyright © Huawei Technologies Co., Ltd. 2020. All rights reserved.

No part of this document may be reproduced or transmitted in any form or by any means without prior written consent of Huawei Technologies Co., Ltd.

Trademarks and Permissions



and other Huawei trademarks are trademarks of Huawei Technologies Co., Ltd.

All other trademarks and trade names mentioned in this document are the property of their respective holders.

Notice

The purchased products, services and features are stipulated by the contract made between Huawei and the customer. All or part of the products, services and features described in this document may not be within the purchase scope or the usage scope. Unless otherwise specified in the contract, all statements, information, and recommendations in this document are provided "AS IS" without warranties, guarantees or representations of any kind, either express or implied.

The information in this document is subject to change without notice. Every effort has been made in the preparation of this document to ensure accuracy of the contents, but all statements, information, and recommendations in this document do not constitute a warranty of any kind, express or implied.

Huawei Technologies Co., Ltd.

Address: Huawei Industrial Base Bantian, Longgang Shenzhen 518129
People's Republic of China

Website: <http://e.huawei.com>

Huawei Certificate System

Huawei Certification follows the "platform + ecosystem" development strategy, which is a new collaborative architecture of ICT infrastructure based on "Cloud-Pipe-Terminal". Huawei has set up a complete certification system consisting of three categories: ICT infrastructure certification, Platform and Service certification and ICT vertical certification, and grants Huawei certification the only all-range technical certification in the industry.

Huawei offers three levels of certification: Huawei Certified ICT Associate (HCIA), Huawei Certified ICT Professional (HCIP), and Huawei Certified ICT Expert (HCIE).

Huawei Certified ICT Associate-Storage (HCIA-Storage) is designed for Huawei engineers, students and ICT industry personnel. HCIA-Storage covers knowledge about storage technology trends, storage basic technologies, storage common advanced technologies, storage business continuity solutions and storage system O&M management.

The HCIA-Storage certificate system introduces you to the industry and market, helps you in innovation, and enables you to stand atop the Storage frontiers.

Huawei Certification





Contents

1 References and Tools	6
1.1 References	6
1.2 Software Tools	6
1.3 Version Description	6
2 Scenario-based Practice on HyperSnap	7
2.1 Course Overview	7
2.2 Objectives	7
2.3 Case Background	7
2.4 Tasks	8
2.4.1 Scenario: Using HyperSnap	8
2.5 Summary and Conclusion	12

1 References and Tools

1.1 References

The commands, documents, and document paths listed in this document are for reference only. The actual commands, documents, and document paths may vary.

Huawei OceanStor Dorado V6 Product Documentation

 **NOTE**

The specifications of HyperSnap vary with products. For details, see the product documentation of the desired product model. You can log in to Huawei's technical support website (<https://support.huawei.com/enterprise/>) and input the name of a document or tool in the search box to search for, browse, and download it.

1.2 Software Tools

PuTTY

 **NOTE**

You are advised to use the open-source software PuTTY to log in to a terminal. You can use the common domain name (putty.org) of PuTTY to browse or download the desired document or tool.

1.3 Version Description

Name	Version	Quantity	Remarks
Storage device	Huawei OceanStor Dorado V6	1	
Windows OS	Windows Server 2012, Windows Server 2016	--	Recommended version
Linux OS	SUSE, Red Hat, CentOS, EulerOS	--	Recommended version

2 Scenario-based Practice on HyperSnap

2.1 Course Overview

This course provides case study and scenario-based practices to help trainees consolidate their knowledge on the use of HyperSnap. HyperSnap is a common advanced storage technology. Before using HyperSnap, you are advised to learn how to configure basic storage services.

2.2 Objectives

- To be able to configure a snapshot of a LUN.
- To be able to roll back data using a snapshot.

2.3 Case Background

NOTE

Cases in this document are examples only. The actual configurations may vary according to actual environments. For details, see the corresponding product document. The names of storage pools and LUNs involved in this document can be customized (for example, LUN_XXX) for different trainees if they use the same device.

An enterprise has an OceanStor all-flash storage device. To shorten the backup window, the enterprise purchased HyperSnap. Help storage engineers get familiar with operations related to HyperSnap.

The following figure shows the live network topology of the enterprise.

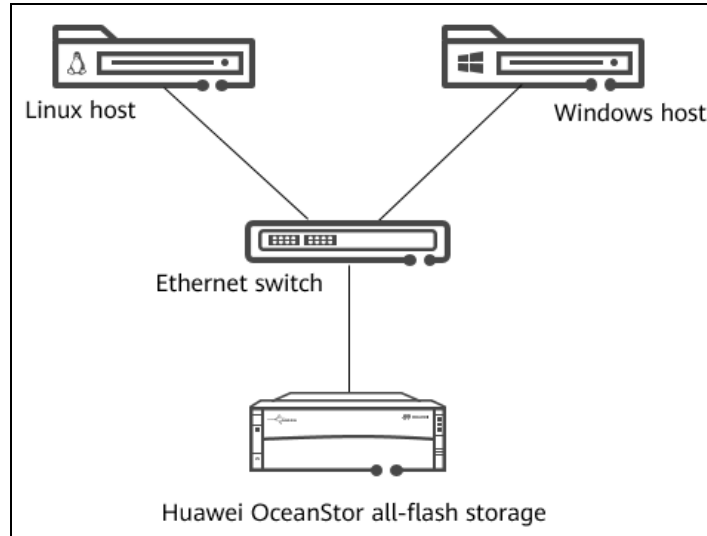

Figure 2-1 Network topology

2.4 Tasks

2.4.1 Scenario: Using HyperSnap

Background

A 5 GB LUN named **LUN_SOUR** has been created and mapped to a host. A file system has been created for **LUN_SOUR** on the host and has been mounted. Two text files **A.txt** and **B.txt** containing characters have been written to **LUN_SOUR**.

Question

What are COW and ROW?

Task 1: Configuring a Snapshot of a LUN

After a snapshot is created for a source LUN, the snapshot stores data of the source LUN at the snapshot creation time point.

Step 1 Draw a flowchart for configuring HyperSnap.

Demonstrate how to configure HyperSnap.

[Suggested Procedure]

For details about how to draw the flowchart, see **Configure > HyperSnap Feature Guide > Configuring and Managing Snapshots of LUNs > Configuring a Snapshot > Flowchart** of the product documentation.

Step 2 View HyperSnap license information.

Before configuring HyperSnap, ensure that the permission for using HyperSnap has been granted. Help the engineer check HyperSnap license information.



[Suggested Procedure]

For details about operations on DeviceManager, see **Configure > HyperSnap Feature Guide > Configuring and Managing Snapshots of LUNs > Configuring a Snapshot > Checking the License** of the product documentation.

For details about operations on the CLI, see **Reference > Command Reference > License Management Commands > license > show license** of the product documentation.

Step 3 Create a snapshot.

Use **LUN_SOUR** as the source LUN. Help the engineer create a snapshot named **Snap01** for **LUN_SOUR** and set the rollback rate to the **Highest**.

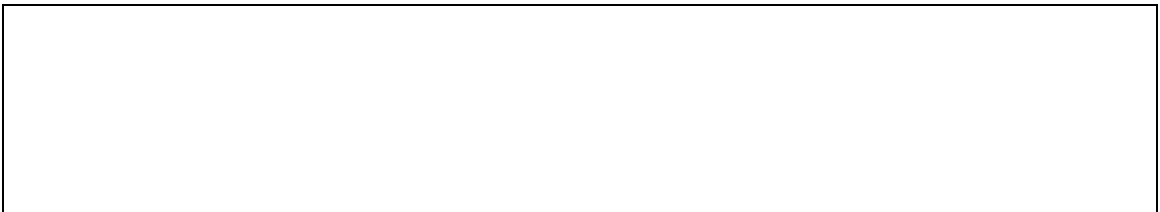

[Suggested Procedure]

For details about operations on DeviceManager, see **Configure > HyperSnap Feature Guide > Configuring and Managing Snapshots of LUNs > Configuring a Snapshot > Creating a Snapshot** of the product documentation.

For details about operations on the CLI, see **Reference > Command Reference > Data Protect Management Commands > lun_snapshot > create snapshot general** of the product documentation.

Question

Why can a snapshot of a LUN be used to recover data without saving all copies of the source LUN?

Task 2: Rolling Back Data Using a Snapshot

After configuring the snapshot of the LUN, the engineer mistakenly modifies data on the source LUN. In this case, the engineer needs to roll back data on the source LUN using the snapshot. Modify the files in **LUN_SOUR** and explain how to roll back the data using the snapshot.

Step 1 Check the snapshot status.

Before the rollback, check whether the snapshot is activated.

[Suggested Procedure]

For details about operations on DeviceManager, see **Configure > HyperSnap Feature Guide > Configuring and Managing Snapshots of LUNs > Managing Snapshots of LUNs > Viewing Snapshots** of the product documentation.

For details about operations on the CLI, see **Reference > Command Reference > Data Protect Management Commands > lun_snapshot > show snapshot available_snapshot** of the product documentation.

Step 2 Cancel the mapping between the source LUN and the host.

To ensure data consistency, stop host services before data rollback. Help the engineer cancel the mapping between **LUN_SOUR** and the host.

[Suggested Procedure]

For details, see **Configure > Basic Storage Service Configuration Guide > Managing Basic Storage Services > Managing LUNs > Unmapping a LUN** of the product documentation.

Step 3 Start data rollback.

Use **Snap01** to roll back data on **LUN_SOUR**. After the rollback is complete, map **LUN_SOUR** to the host again, mount the file system, and check whether the data on **LUN_SOUR** has been rolled back to the time point when the snapshot was activated.

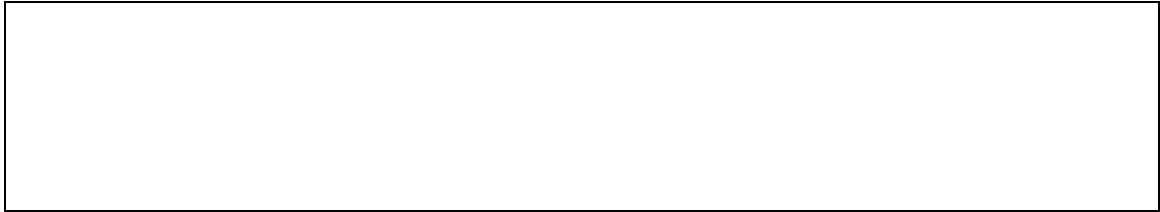

[Suggested Procedure]

For details about operations on DeviceManager, see **Configure > HyperSnap Feature Guide > Configuring and Managing Snapshots of LUNs > Managing Snapshots of LUNs > Rolling Back a Snapshot** of the product documentation.

For details about operations on the CLI, see **Reference > Command Reference > Data Protect Management Commands > lun_snapshot > change snapshot restore** of the product documentation.

Question

For a writable snapshot, if data on the snapshot LUN is modified, can the snapshot LUN be used to restore data on the source LUN?

Task 3: Managing Snapshots

After configuring the snapshot and rolling back data using the snapshot, the engineer wants to learn about routine snapshot management operations, such as managing and modifying snapshot properties. Help the engineer get familiar with these operations.

Step 1 Modify the snapshot.

View the snapshot information, modify the snapshot name to **Snap_Test**, and set the rollback rate to **Low**.



[Suggested Procedure]

For details about operations on DeviceManager, see **Configure > HyperSnap Feature Guide > Configuring and Managing Snapshots of LUNs > Managing Snapshots of LUNs > Modifying a Snapshot** of the product documentation.

For details about operations on the CLI, see **Configure > HyperSnap Feature Guide > Configuring and Managing Snapshots of LUNs > Managing Snapshots of LUNs > Modifying a Snapshot** of the product documentation.

Step 2 Delete the snapshot.

After completing the preceding operations, delete the snapshot.

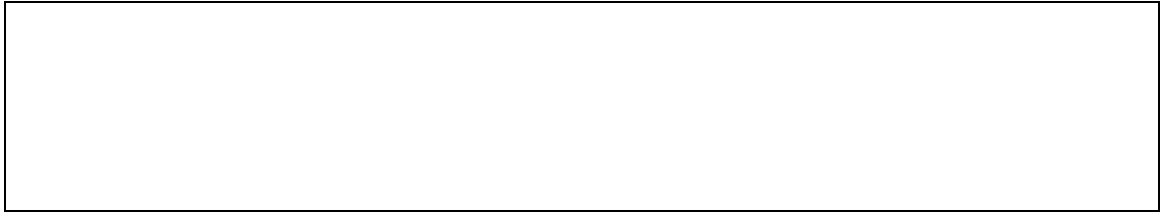

[Suggested Procedure]

For details about operations on DeviceManager, see **Configure > HyperSnap Feature Guide > Configuring and Managing Snapshots of LUNs > Managing Snapshots of LUNs > Deleting a Snapshot** of the product documentation.

For details about operations on the CLI, see **Reference > Command Reference > Data Protect Management Commands > lun_snapshot > delete snapshot** of the product documentation.

Discussion

Why can the Huawei OceanStor all-flash storage system implement lossless performance using the ROW technology?

2.5 Summary and Conclusion

My Opinion:

Scenario-based Practice on HyperClone

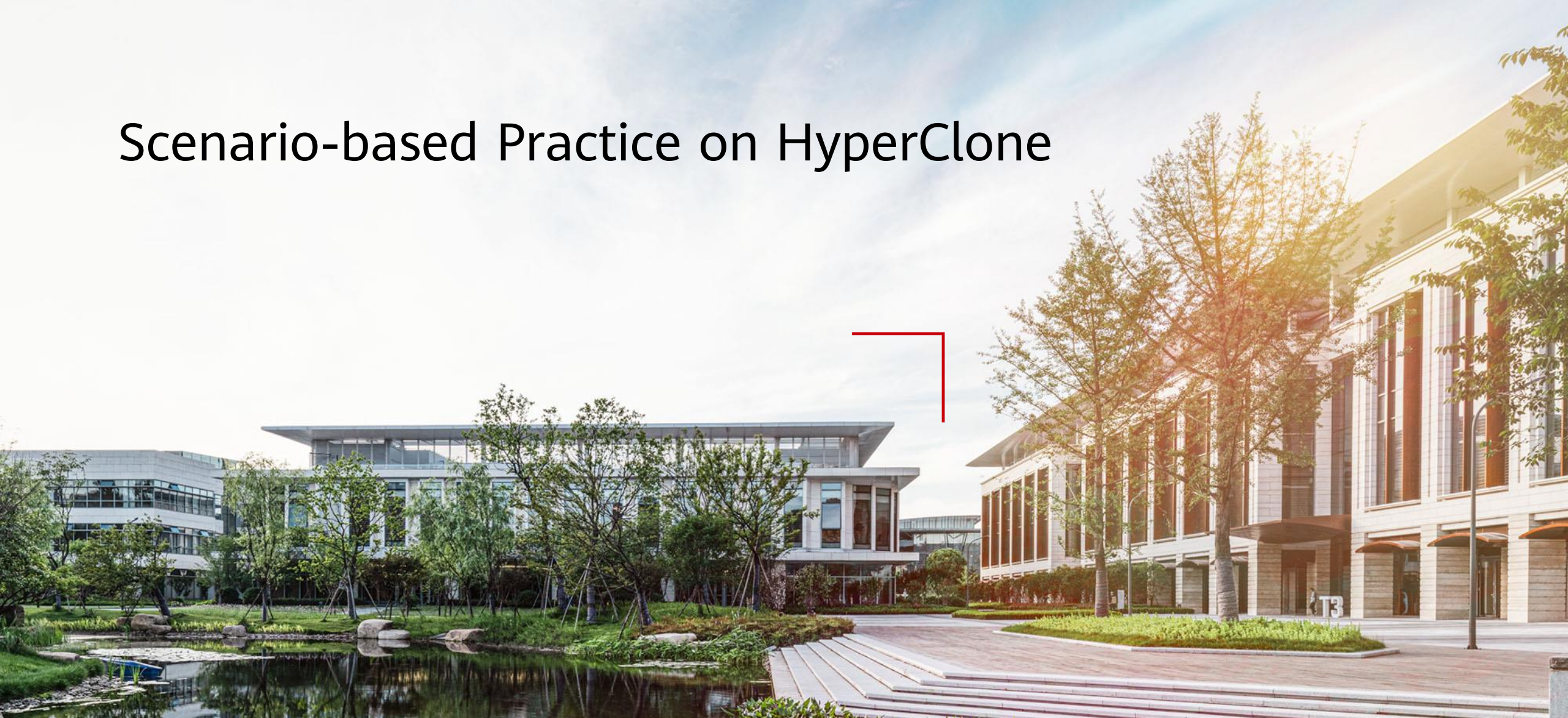

Background

- An enterprise has a Huawei OceanStor all-flash storage device and has purchased the HyperClone license. Help storage engineers get familiar with operations related to HyperClone.

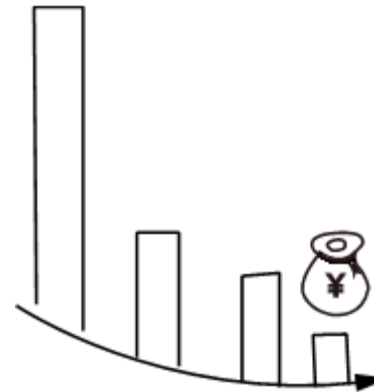

- **Note:** Cases in this course are examples only. The actual configurations may vary according to actual environments. For details, see the corresponding product documentation.

Networking Diagram

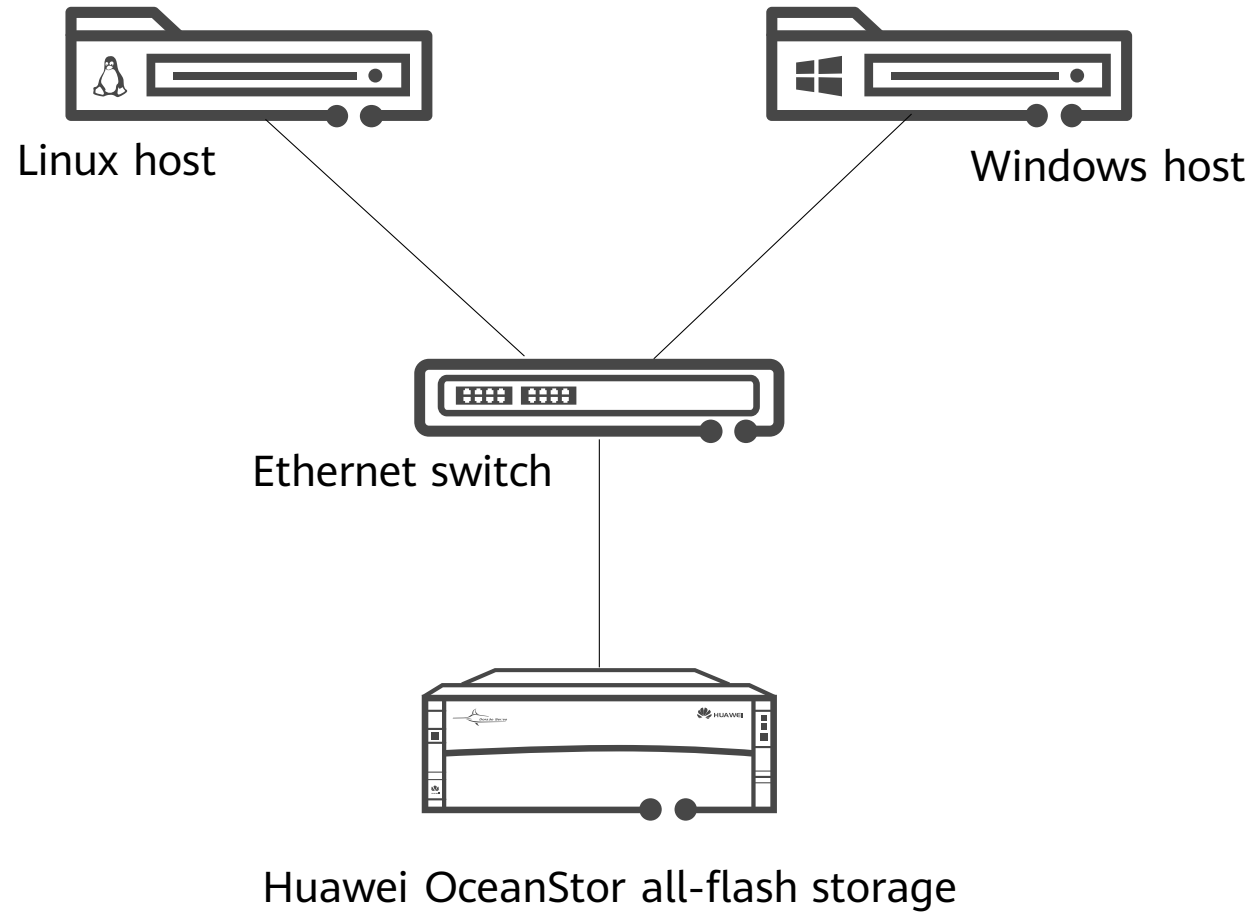

Practice Mode

Objectives

- To be able to configure HyperClone.
- To understand how to manage clones.

Procedure

- Topic introduction
- Case study
- Scenario-based practice
- Presentation
- Evaluation and feedback

Opinion
Sharing

Form

- Two or three persons form a group.
- Each group prepares materials for presentation.
- After the presentation of each group, the technical officer asks questions, and the evaluator gives feedback and scores.

Assessment Criteria

- Accuracy
- Completeness
- Presentation
- Time control

Scenario-based Practice

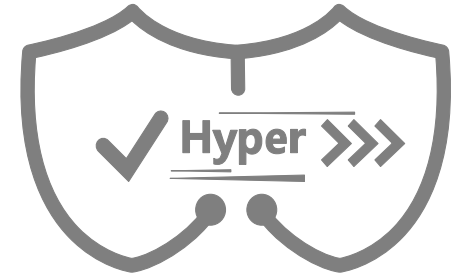
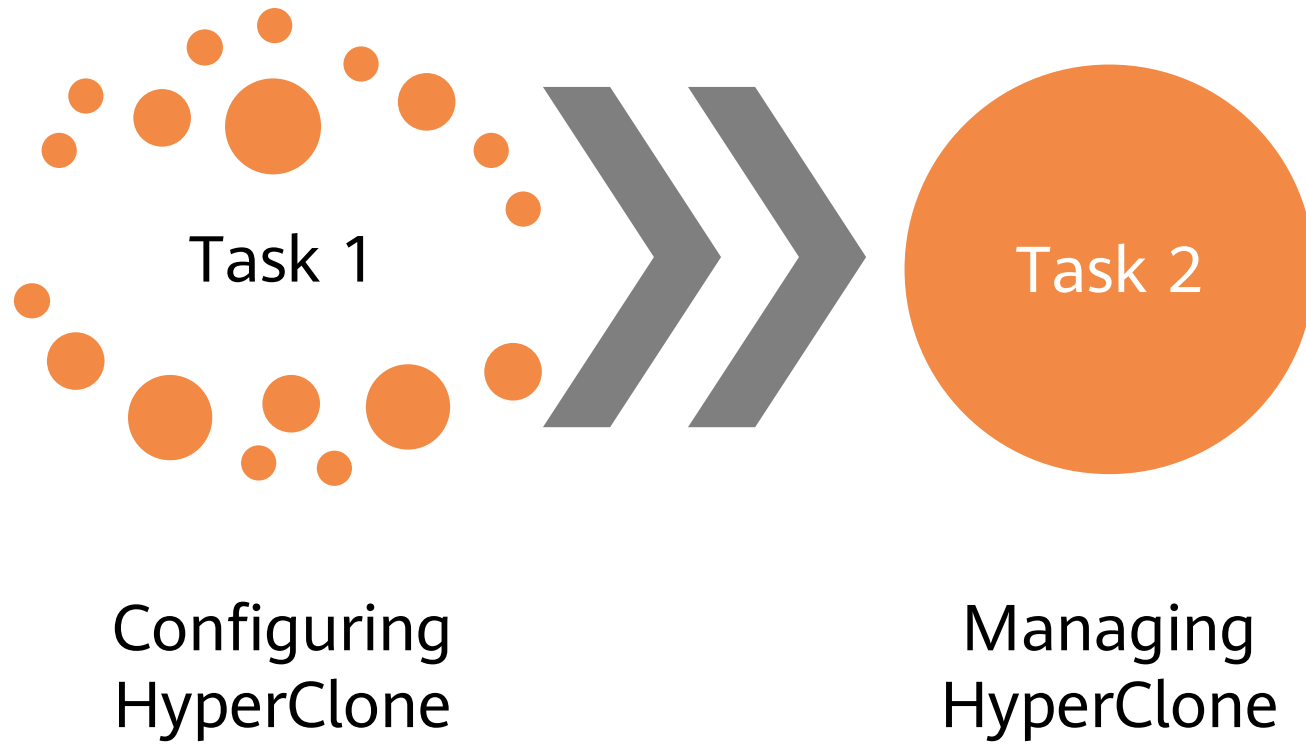

Question

- What is the difference between HyperClone and HyperSnap?
- Suggested answer:
 - HyperSnap does not physically isolate the source LUN because the snapshot shares data with the source LUN. If the source LUN is physically damaged, the snapshot will be affected.
 - HyperClone allows users to create multiple physical copies of a source LUN and assign them to different applications. In this way, these applications can access the same data simultaneously while having no impact on the source LUN's data.

Task 1: Configuring HyperClone

- Draw a flowchart for configuring HyperClone.
- View HyperClone license information.
- Create a clone pair.

Question

- In Huawei OceanStor all-flash storage systems, what will happen if the capacity of the source LUN is inconsistent with that of the target LUN in a clone pair?
- Suggested answer:
 - If the capacity of the source LUN is different from that of the target LUN, the clone pair cannot be synchronized. You can modify the capacity of the target LUN and then synchronize the pair.

Task 2: Managing HyperClone

- Pause synchronization.
- Resume synchronization.
- Delete a clone pair.

Discussion

- After clone synchronization is complete, can users perform synchronization again?
- Suggested answer:
 - After clone synchronization is complete, users can perform synchronization again. In this case, only the differential data between the two LUNs is synchronized.

Trainee Assessment

Item	Description	Score	Rating
Accuracy	The trainee's explanation is logical and fluent.	1 to 10	
Completeness	The answers presented by the trainee are complete.	1 to 20	
Presentation	The trainee presents answers clearly.	1 to 10	
Time control	The trainee provides the correct answers within the specified time.	1 to 10	
Overall		/	

Thank you.

把数字世界带入每个人、每个家庭、
每个组织，构建万物互联的智能世界。

Bring digital to every person, home, and
organization for a fully connected,
intelligent world.

**Copyright©2020 Huawei Technologies Co., Ltd.
All Rights Reserved.**

The information in this document may contain predictive statements including, without limitation, statements regarding the future financial and operating results, future product portfolio, new technology, etc. There are a number of factors that could cause actual results and developments to differ materially from those expressed or implied in the predictive statements. Therefore, such information is provided for reference purpose only and constitutes neither an offer nor an acceptance. Huawei may change the information at any time without notice.



Huawei Storage Certification Training

HCIA-Storage HyperClone Scenario-based Practice

(For Trainees)



HUAWEI

HUAWEI TECHNOLOGIES CO., LTD.

Copyright © Huawei Technologies Co., Ltd. 2020. All rights reserved.

No part of this document may be reproduced or transmitted in any form or by any means without prior written consent of Huawei Technologies Co., Ltd.

Trademarks and Permissions



and other Huawei trademarks are trademarks of Huawei Technologies Co., Ltd.

All other trademarks and trade names mentioned in this document are the property of their respective holders.

Notice

The purchased products, services and features are stipulated by the contract made between Huawei and the customer. All or part of the products, services and features described in this document may not be within the purchase scope or the usage scope. Unless otherwise specified in the contract, all statements, information, and recommendations in this document are provided "AS IS" without warranties, guarantees or representations of any kind, either express or implied.

The information in this document is subject to change without notice. Every effort has been made in the preparation of this document to ensure accuracy of the contents, but all statements, information, and recommendations in this document do not constitute a warranty of any kind, express or implied.

Huawei Technologies Co., Ltd.

Address: Huawei Industrial Base Bantian, Longgang Shenzhen 518129
People's Republic of China

Website: <http://e.huawei.com>

Huawei Certificate System

Huawei Certification follows the "platform + ecosystem" development strategy, which is a new collaborative architecture of ICT infrastructure based on "Cloud-Pipe-Terminal". Huawei has set up a complete certification system consisting of three categories: ICT infrastructure certification, Platform and Service certification and ICT vertical certification, and grants Huawei certification the only all-range technical certification in the industry.

Huawei offers three levels of certification: Huawei Certified ICT Associate (HCIA), Huawei Certified ICT Professional (HCIP), and Huawei Certified ICT Expert (HCIE).

Huawei Certified ICT Associate-Storage (HCIA-Storage) is designed for Huawei engineers, students and ICT industry personnel. HCIA-Storage covers knowledge about storage technology trends, storage basic technologies, storage common advanced technologies, storage business continuity solutions and storage system O&M management.

The HCIA-Storage certificate system introduces you to the industry and market, helps you in innovation, and enables you to stand atop the Storage frontiers.



Huawei Certification

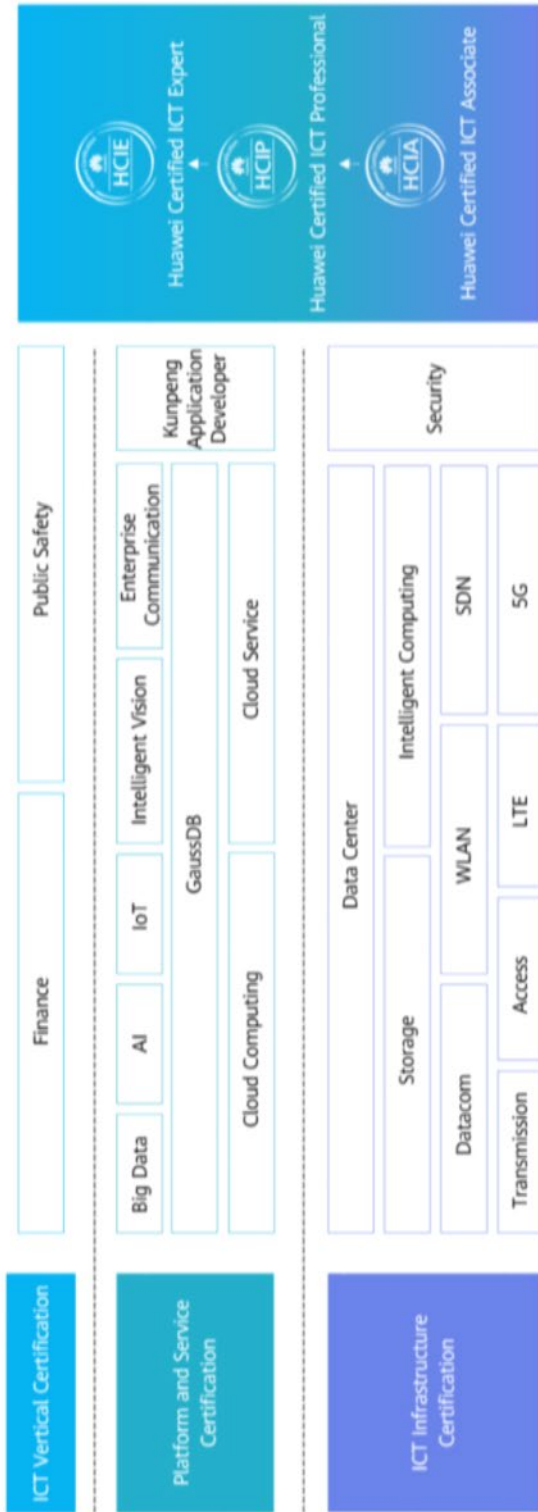



Contents

1 References and Tools	4
1.1 References	4
1.2 Software Tools	4
1.3 Version Description	4
2 Scenario-based Practice on HyperClone.....	5
2.1 Course Overview	5
2.2 Objectives	5
2.3 Case Background	5
2.4 Tasks.....	6
2.4.1 Scenario: Using HyperClone	6
2.5 Summary and Conclusion	9

1 References and Tools

1.1 References

The commands, documents, and document paths listed in this document are for reference only. The actual commands, documents, and document paths may vary.

Huawei OceanStor Dorado V6 Product Documentation

 **NOTE**

The specifications of HyperClone vary with products. For details, see the product documentation of the desired product model. You can log in to Huawei's technical support website (<https://support.huawei.com/enterprise/>) and input the name of a document or tool in the search box to search for, browse, and download it.

1.2 Software Tools

PuTTY

 **NOTE**

You are advised to use the open-source software PuTTY to log in to a terminal. You can use the common domain name (putty.org) of PuTTY to browse or download the desired document or tool.

1.3 Version Description

Name	Version	Quantity	Remarks
Storage device	Huawei OceanStor Dorado V6	1	
Windows OS	Windows Server 2012, Windows Server 2016	--	Recommended version
Linux OS	SUSE, Red Hat, CentOS, EulerOS	--	Recommended version

2 Scenario-based Practice on HyperClone

2.1 Course Overview

This course provides case study and scenario-based practices to help trainees consolidate their knowledge on the use of HyperClone. HyperClone is a common advanced storage technology. Before using HyperClone, you are advised to learn how to configure basic storage services.

2.2 Objectives

- To be able to configure HyperClone
- To understand how to manage clones

2.3 Case Background

NOTE

Cases in this document are examples only. The actual configuration may vary according to actual environments. For details, see the corresponding product document. The names of storage pools and LUNs involved in this document can be customized (for example, LUN_XXX) for different trainees if they use the same device.

An enterprise has a Huawei OceanStor all-flash storage device and has purchased the HyperClone license. Help storage engineers get familiar with operations related to HyperClone.

The following figure shows the live network topology of the enterprise.

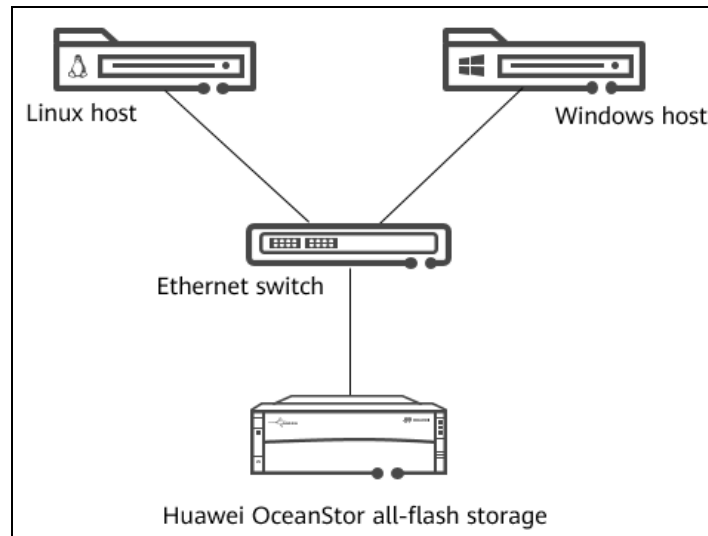

Figure 2-1 Network topology

2.4 Tasks

2.4.1 Scenario: Using HyperClone

Background

A 5 GB LUN named **LUN_SOUR** has been created and mapped to a host. A file system has been created for **LUN_SOUR** on the host and has been mounted. A text file **A.txt** containing characters has been written to **LUN_SOUR**.

Question

What is the difference between HyperClone and HyperSnap?

Task 1: Configuring HyperClone

Step 1 Draw a flowchart for configuring HyperClone.

Demonstrate how to configure HyperClone.

[Suggested Procedure]

For details about how to draw a flowchart, see **Configure > HyperClone Feature Guide > Configuring HyperClone > Configuration Process** in the product documentation.

Step 2 View HyperClone license information.

Before configuring HyperClone, ensure that the permission for using HyperClone has been granted. Help the engineer check HyperClone license information.

[Suggested Procedure]

For details about operations on DeviceManager, see **Configure > HyperClone Feature Guide > Configuring HyperClone > Checking the License** in the product documentation.

For details about operations on the CLI, see **Reference > Command Reference > License Management Commands > license > show license** in the product documentation.

Step 3 Create a clone pair.

Help the engineer create a clone pair for **LUN_SOUR**. Set the target LUN name to **LUN_DEST**.

[Suggested Procedure]

For details about operations on DeviceManager, see **Configure > HyperClone Feature Guide > Configuring HyperClone > Creating a Clone Pair** in the product documentation.

For details about operations on the CLI, see **Reference > Command Reference > Data Protection Management Commands > hyper_copy > create clone general** in the product documentation.

Question

In Huawei OceanStor all-flash storage systems, what will happen if the capacity of the source LUN is inconsistent with that of the target LUN in a clone pair?

Task 2: Managing HyperClone

In practice, unexpected situations may occur during the use of HyperClone, for example, the service load increases sharply during clone synchronization. In such cases, the engineer should pause the synchronization and resume it when the service load is light. Help the engineer understand how to pause and resume clone synchronization.

Step 1 Pause synchronization.

Help the engineer pause clone synchronization.

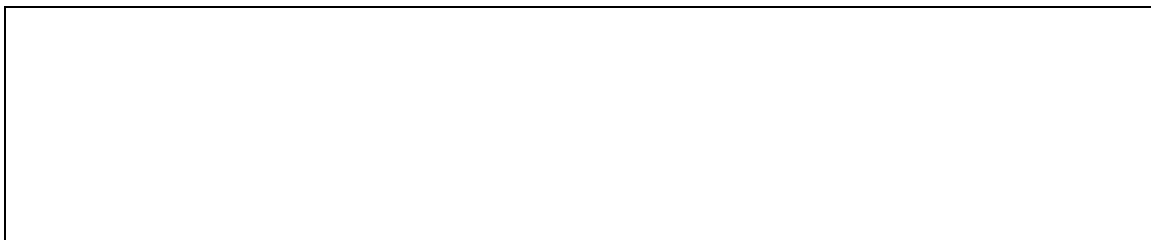

[Suggested Procedure]

For details about operations on DeviceManager, see **Configure > HyperClone Feature Guide > Managing Clone Pairs > Pausing Synchronizing or Reversely Synchronizing a Clone Pair** in the product documentation.

For details about operations on the CLI, see **Reference > Command Reference > Data Protection Management Commands > hyper_copy > change clone restore** in the product documentation.

Step 2 Resume synchronization.

Help the engineer resume clone synchronization.



[Suggested Procedure]

For details about operations on DeviceManager, see **Configure > HyperClone Feature Guide > Managing Clone Pairs > Resuming Synchronizing or Reversely Synchronizing a Clone Pair** in the product documentation.

For details about operations on the CLI, see **Reference > Command Reference > Data Protection Management Commands > hyper_copy > change clone restore** in the product documentation.

Step 3 Delete a clone pair.

After completing the preceding operations, delete the clone pair.



[Suggested Procedure]

For details about operations on DeviceManager, see **Configure > HyperClone Feature Guide > Managing Clone Pairs > Deleting a Clone Pair** in the product documentation.

For details about operations on the CLI, see **Reference > Command Reference > Data Protection Management Commands > hyper_copy > delete clone** in the product documentation.

Discussion

After clone synchronization is complete, can users perform synchronization again?

2.5 Summary and Conclusion

My Opinion:

Scenario-based Practice on SmartMigration

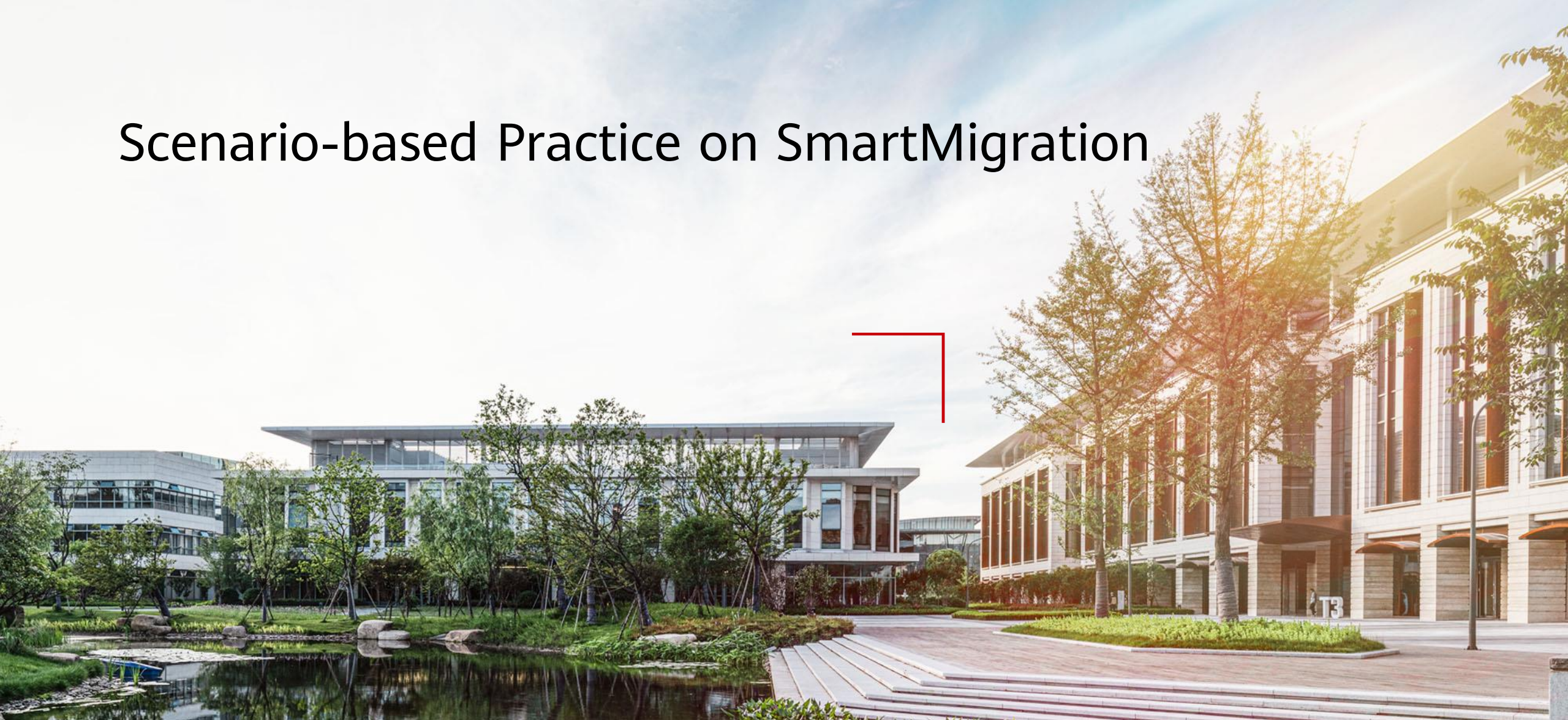

Background

- An enterprise has a Huawei OceanStor all-flash storage device and purchases SmartMigration for data migration. Help storage engineers get familiar with operations related to SmartMigration.

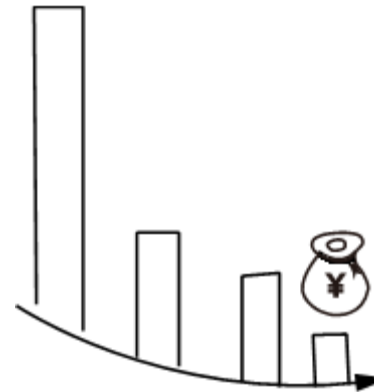

- **Note:** Cases in this course are examples only. The actual configurations may vary according to actual environments. For details, see the corresponding product documentation.

Networking Diagram

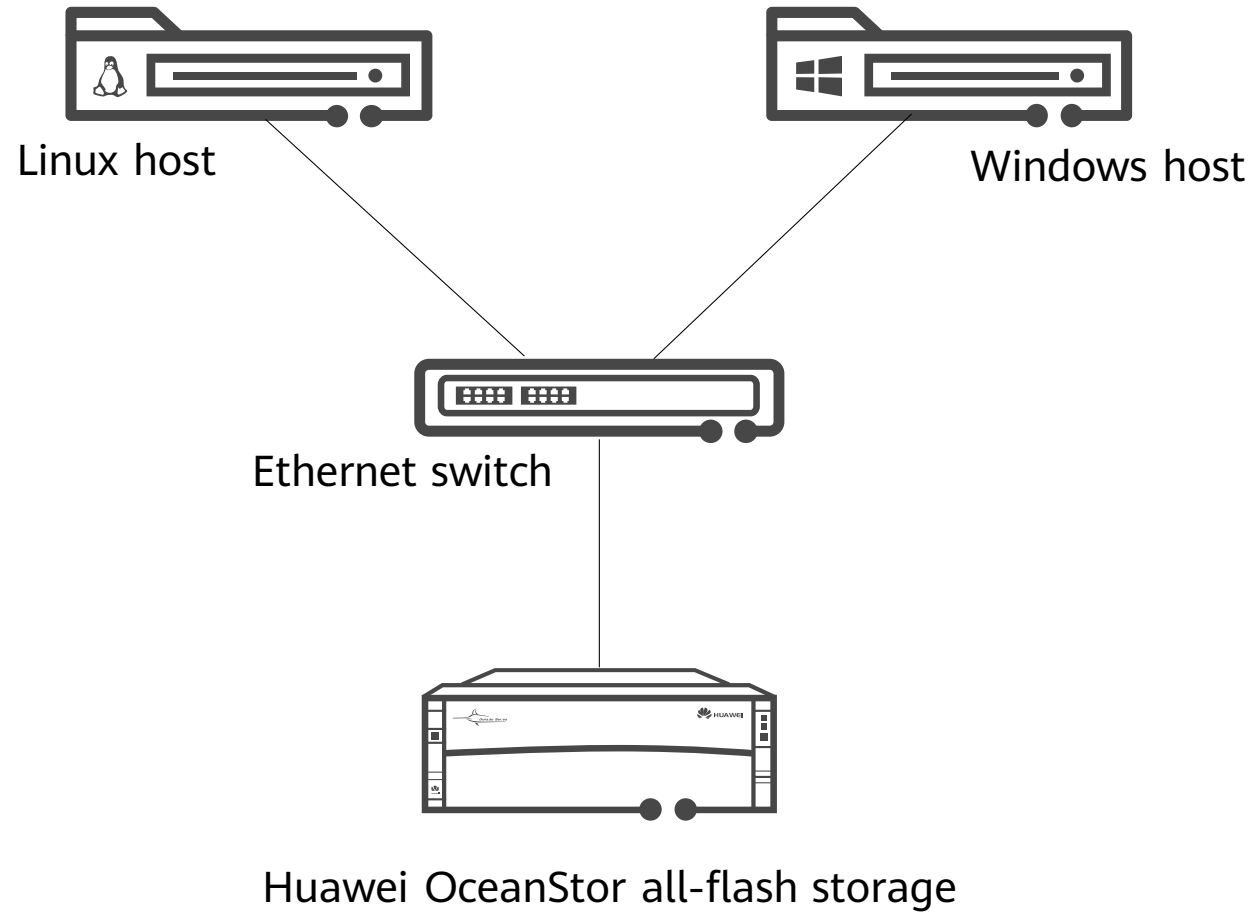

Practice Mode

Objectives

- To know the application scenarios of SmartMigration.
- To be able to configure SmartMigration.

Procedure

- Topic introduction
- Case study
- Scenario-based practice
- Presentation
- Evaluation and feedback

Opinion
Sharing

Form

- Two or three persons form a group.
- Each group prepares materials for presentation.
- After the presentation of each group, the technical officer asks questions, and the evaluator gives feedback and scores.

Assessment Criteria

- Accuracy
- Completeness
- Presentation
- Time control

Scenario-based Practice

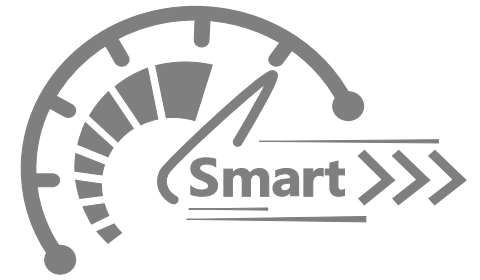
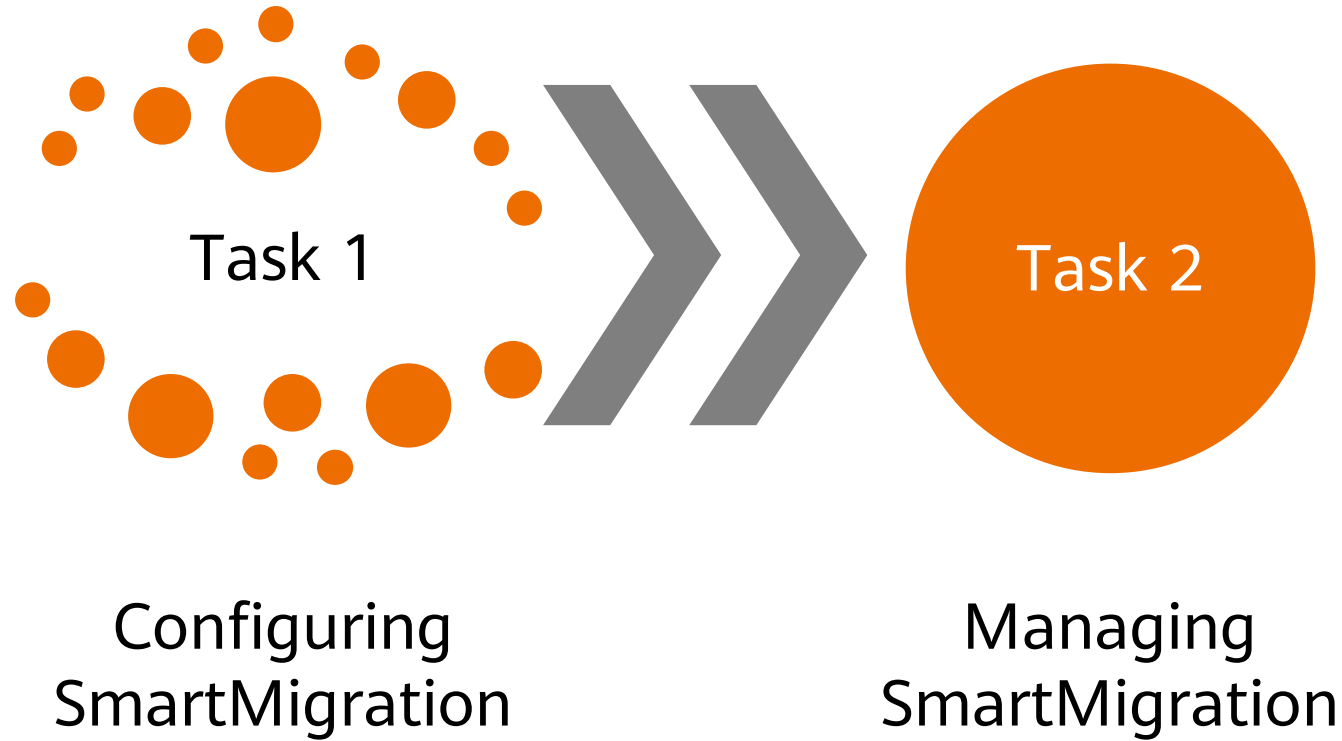

Question

- What are the differences between SmartMigration and HyperClone?
- Suggested answer:
 - SmartMigration migrates services without interrupting host services. Data can be migrated within a storage system, and can be migrated between heterogeneous storage systems by working with SmartVirtualization. Only one-to-one mode is supported.
 - HyperClone implements LUN-level full backup of data without interrupting services. Data cannot be backed up across storage systems, and one-to-many mode is supported. It is applicable to data backup and restoration, data reproduction, and data analysis scenarios.

Task 1: Configuring SmartMigration

- Draw a flowchart for configuring SmartMigration.
- View SmartMigration license information.
- Create a SmartMigration task.
- Split a SmartMigration pair.

Question

- Can SmartMigration be used to migrate data between heterogeneous storage systems?
- Suggested answer:
 - Yes. Working with the LUN takeover function of SmartVirtualization, SmartMigration can migrate data between heterogeneous storage systems. Before creating a SmartMigration task, let the local storage system take over a LUN from a heterogeneous storage system. Then, use the LUN as the source LUN of the SmartMigration task and migrate services from the heterogeneous storage system to the target LUN on the local storage system.

Task 2: Managing SmartMigration

- Modify the migration rate.
- Delete a SmartMigration task.

Discussion

- In addition to the migration rate, what property of SmartMigration can be modified?
- Suggested answer:
 - The split mode can be modified. There are automatic and manual modes. In automatic mode, the SmartMigration pair is automatically split after data synchronization is complete. After the splitting is complete, the migration is complete. In manual mode, after data synchronization is complete, the SmartMigration pair must be split manually. After the splitting is complete, the migration is complete.

Trainee Assessment

Item	Description	Score	Rating
Accuracy	The trainee's explanation is logical and fluent.	1 to 10	
Completeness	The answers presented by the trainee are complete.	1 to 20	
Presentation	The trainee presents answers clearly.	1 to 10	
Time control	The trainee provides the correct answers within the specified time.	1 to 10	
Overall		/	

Thank you.

把数字世界带入每个人、每个家庭、
每个组织，构建万物互联的智能世界。

Bring digital to every person, home, and
organization for a fully connected,
intelligent world.

**Copyright©2020 Huawei Technologies Co., Ltd.
All Rights Reserved.**

The information in this document may contain predictive statements including, without limitation, statements regarding the future financial and operating results, future product portfolio, new technology, etc. There are a number of factors that could cause actual results and developments to differ materially from those expressed or implied in the predictive statements. Therefore, such information is provided for reference purpose only and constitutes neither an offer nor an acceptance. Huawei may change the information at any time without notice.



Huawei Storage Certification Training

HCIA-Storage SmartMigration Scenario-based Practice

(For Trainees)



HUAWEI

HUAWEI TECHNOLOGIES CO., LTD.

Copyright © Huawei Technologies Co., Ltd. 2020. All rights reserved.

No part of this document may be reproduced or transmitted in any form or by any means without prior written consent of Huawei Technologies Co., Ltd.

Trademarks and Permissions



and other Huawei trademarks are trademarks of Huawei Technologies Co., Ltd.

All other trademarks and trade names mentioned in this document are the property of their respective holders.

Notice

The purchased products, services and features are stipulated by the contract made between Huawei and the customer. All or part of the products, services and features described in this document may not be within the purchase scope or the usage scope. Unless otherwise specified in the contract, all statements, information, and recommendations in this document are provided "AS IS" without warranties, guarantees or representations of any kind, either express or implied.

The information in this document is subject to change without notice. Every effort has been made in the preparation of this document to ensure accuracy of the contents, but all statements, information, and recommendations in this document do not constitute a warranty of any kind, express or implied.

Huawei Technologies Co., Ltd.

Address: Huawei Industrial Base Bantian, Longgang Shenzhen 518129
People's Republic of China

Website: <http://e.huawei.com>

Huawei Certificate System

Huawei Certification follows the "platform + ecosystem" development strategy, which is a new collaborative architecture of ICT infrastructure based on "Cloud-Pipe-Terminal". Huawei has set up a complete certification system consisting of three categories: ICT infrastructure certification, Platform and Service certification and ICT vertical certification, and grants Huawei certification the only all-range technical certification in the industry.

Huawei offers three levels of certification: Huawei Certified ICT Associate (HCIA), Huawei Certified ICT Professional (HCIP), and Huawei Certified ICT Expert (HCIE).

Huawei Certified ICT Associate-Storage (HCIA-Storage) is designed for Huawei engineers, students and ICT industry personnel. HCIA-Storage covers knowledge about storage technology trends, storage basic technologies, storage common advanced technologies, storage business continuity solutions and storage system O&M management.

The HCIA-Storage certificate system introduces you to the industry and market, helps you in innovation, and enables you to stand atop the Storage frontiers.

Huawei Certification





Contents

1 References and Tools	4
1.1 References	4
1.2 Software Tools	4
1.3 Version Description	4
2 Scenario-based Practice on SmartMigration	5
2.1 Course Overview	5
2.2 Objectives	5
2.3 Case Background	5
2.4 Tasks	6
2.4.1 Scenario: Using SmartMigration	6
2.5 Summary and Conclusion	9

1 References and Tools

1.1 References

The commands, documents, and document paths listed in this document are for reference only. The actual commands, documents, and document paths may vary.

Huawei OceanStor Dorado V6 Product Documentation

NOTE

The specifications of SmartMigration vary with products. For details, see the product documentation of the desired product model. You can log in to Huawei's technical support website (<https://support.huawei.com/enterprise/>) and input the name of a document or tool in the search box to search for, browse, and download the desired document or tool.

1.2 Software Tools

PuTTY

NOTE

You are advised to use the open-source software PuTTY to log in to a terminal. You can use the common domain name (putty.org) of PuTTY to browse or download the desired document or tool.

1.3 Version Description

Name	Version	Quantity	Remarks
Storage device	Huawei OceanStor Dorado V6	1	
Windows OS	Windows Server 2012, Windows Server 2016	--	Recommended version
Linux OS	SUSE, Red Hat, CentOS, EulerOS	--	Recommended version

2 Scenario-based Practice on SmartMigration

2.1 Course Overview

This course provides case study and scenario-based practices to help trainees consolidate their knowledge on the use of SmartMigration. SmartMigration is a common advanced storage technology. Before using SmartMigration, you are advised to learn how to configure basic storage services.

2.2 Objectives

- To know the application scenarios of SmartMigration
- To be able to configure SmartMigration

2.3 Case Background

NOTE

Cases in this document are examples only. The actual configurations may vary according to actual environments. For details, see the corresponding product document. The names of storage pools and LUNs involved in this document can be customized (for example, LUN_XXX) for different trainees if they use the same device.

An enterprise has a Huawei OceanStor all-flash storage device and purchases SmartMigration for data migration. Help storage engineers get familiar with operations related to SmartMigration.

The following figure shows the live network topology of the enterprise.

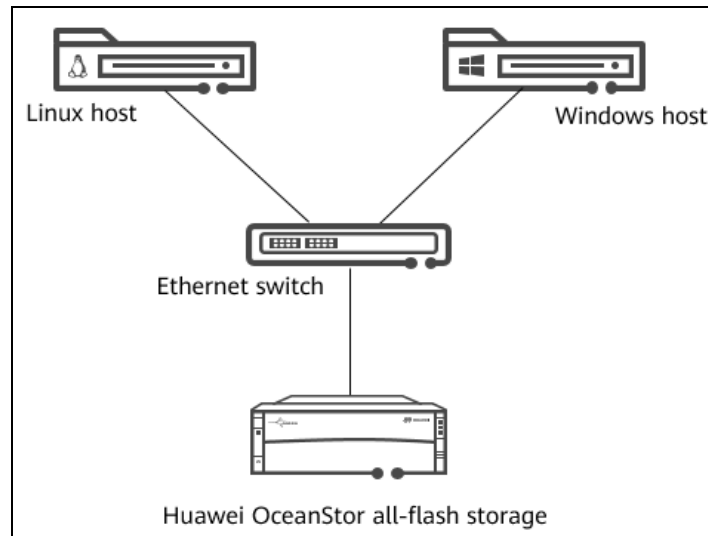

Figure 2-1 Network topology

2.4 Tasks

2.4.1 Scenario: Using SmartMigration

Background

The enterprise creates two storage pools named **SP_SOUR** and **SP_DEST**. A storage engineer maps a 5 GB LUN named **LUN_SOUR** in storage pool **SP_SOUR** to the host. A file system has been created for **LUN_SOUR** on the host and has been mounted. A text file **A.txt** containing characters has been written to **LUN_SOUR**. Data in **LUN_SOUR** is to be migrated to **LUN_DEST**.

Question

What are the differences between SmartMigration and HyperClone?

Task 1: Configuring SmartMigration

Help the engineer configure SmartMigration.

Step 1 Draw a flowchart for configuring SmartMigration.

Demonstrate how to configure SmartMigration.

[Suggested Procedure]

For details about how to draw a flowchart, see **Configure > SmartMigration Feature Guide > Configuring SmartMigration Between Storage Systems > Configuration Process** in the product documentation.

Step 2 View SmartMigration license information.

Before configuring SmartMigration, ensure that the permission for using SmartMigration has been granted. Help the engineer check SmartMigration license information.

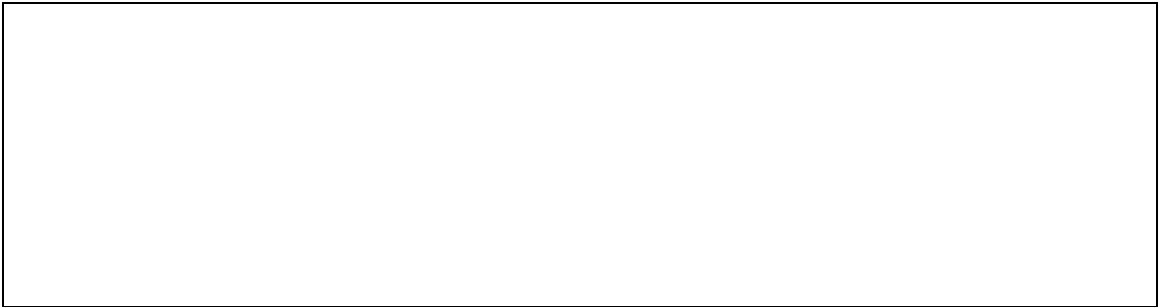

[Suggested Procedure]

For details about operations on DeviceManager, see **Configure > SmartMigration Feature Guide > Configuring SmartMigration Between Storage Systems > Checking the License File** in the product documentation.

For details about operations on the CLI, see **Reference > Command Reference > License Management Commands > license > show license** in the product documentation.

Step 3 Create a SmartMigration task.

Help the engineer create a SmartMigration task. **Use LUN_SOUR** as the source LUN and select **SP_DEST** as the storage pool where the target LUN resides. Set the migration rate to **Low** and split mode to **Manual**.

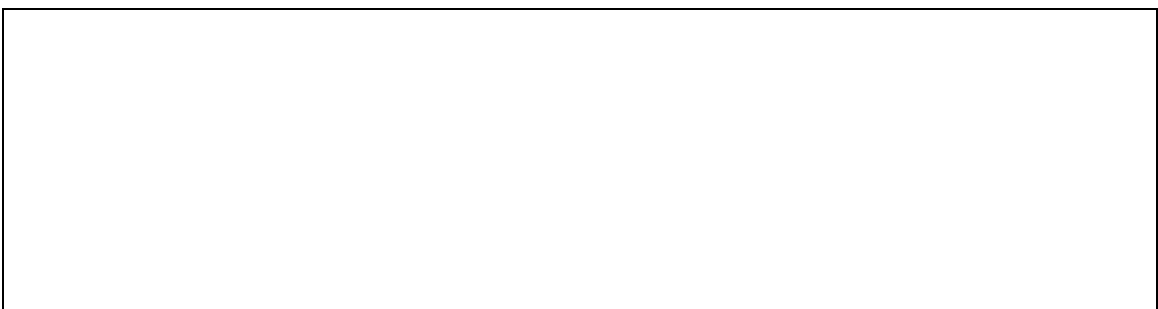

[Suggested Procedure]

For details about operations on DeviceManager, see **Configure > SmartMigration Feature Guide > Configuring SmartMigration Between Storage Systems > Creating a SmartMigration Task** in the product documentation.

For details about operations on the CLI, see **Reference > Command Reference > Storage Domain Management Commands > smart_migration > create lun_migration** in the product documentation.

Step 4 Split a SmartMigration pair.

The target LUN can save the data copy of the source LUN at the split point in time only after the SmartMigration pair is split. The data copy can be used for application tests for the enterprise. Help the engineer split the SmartMigration pair and stop the synchronization between the source LUN and target LUN.



[Suggested Procedure]

For details about operations on DeviceManager, see **Configure > SmartMigration Feature Guide > Configuring SmartMigration Between Storage Systems > Splitting a SmartMigration Pair** in the product documentation.

For details about operations on the CLI, see **Reference > Command Reference > Storage Domain Management Commands > smart_migration > change lun_migration_split consistency** in the product documentation.

Question

Can SmartMigration be used to migrate data between heterogeneous storage systems?

Task 2: Managing SmartMigration

After configuring SmartMigration, help the engineer get familiar with snapshot management operations.

Step 1 Modify the migration rate.

The engineer determines to perform the migration at night when the service load is light. If the migration rate is **Low**, the migration may take a long time and affect services in the daytime. Help the engineer modify the migration rate to **Highest**.

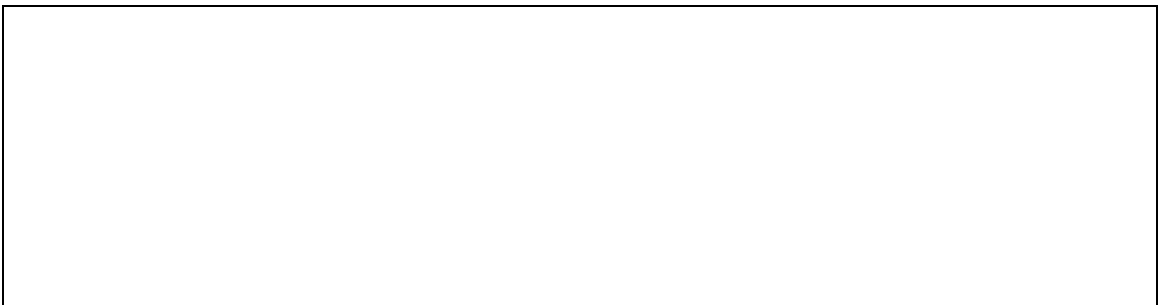

[Suggested Procedure]

For details about operations on DeviceManager, see **Configure > SmartMigration Feature Guide > Managing SmartMigration > Modifying the Properties of a SmartMigration Task** in the product documentation.

For details about operations on the CLI, see **Reference > Command Reference > Storage Domain Management Commands > smart_migration > change lun_migration** in the product documentation.

Step 2 Delete a SmartMigration task.

Help the engineer delete the SmartMigration task and redundant LUNs created during the migration.

[Suggested Procedure]

For details about operations on DeviceManager, see **Configure > SmartMigration Feature Guide > Managing SmartMigration > Deleting a SmartMigration Task** in the product documentation.

For details about operations on the CLI, see **Reference > Command Reference > Storage Domain Management Commands > smart_migration > delete lun_migration** in the product documentation.

Discussion

In addition to the migration rate, what property of SmartMigration can be modified?

2.5 Summary and Conclusion

My Opinion:

Scenario-based Practice of Storage O&M management



Background

An enterprise has completed the acceptance of project X. In this case, multiple Huawei OceanStor all-flash storage devices (such as Huawei OceanStor Dorado V6) are added to the data center. Devices have been installed and services have been deployed. Routine maintenance and management are required to ensure the normal running of devices and the stability and reliability of services.

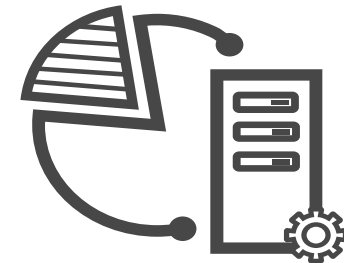
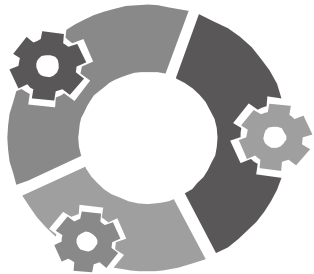

- **Note:** Cases in this course are examples only. The actual configurations may vary according to actual environments. For details, see the corresponding product documentation.

Networking Diagram

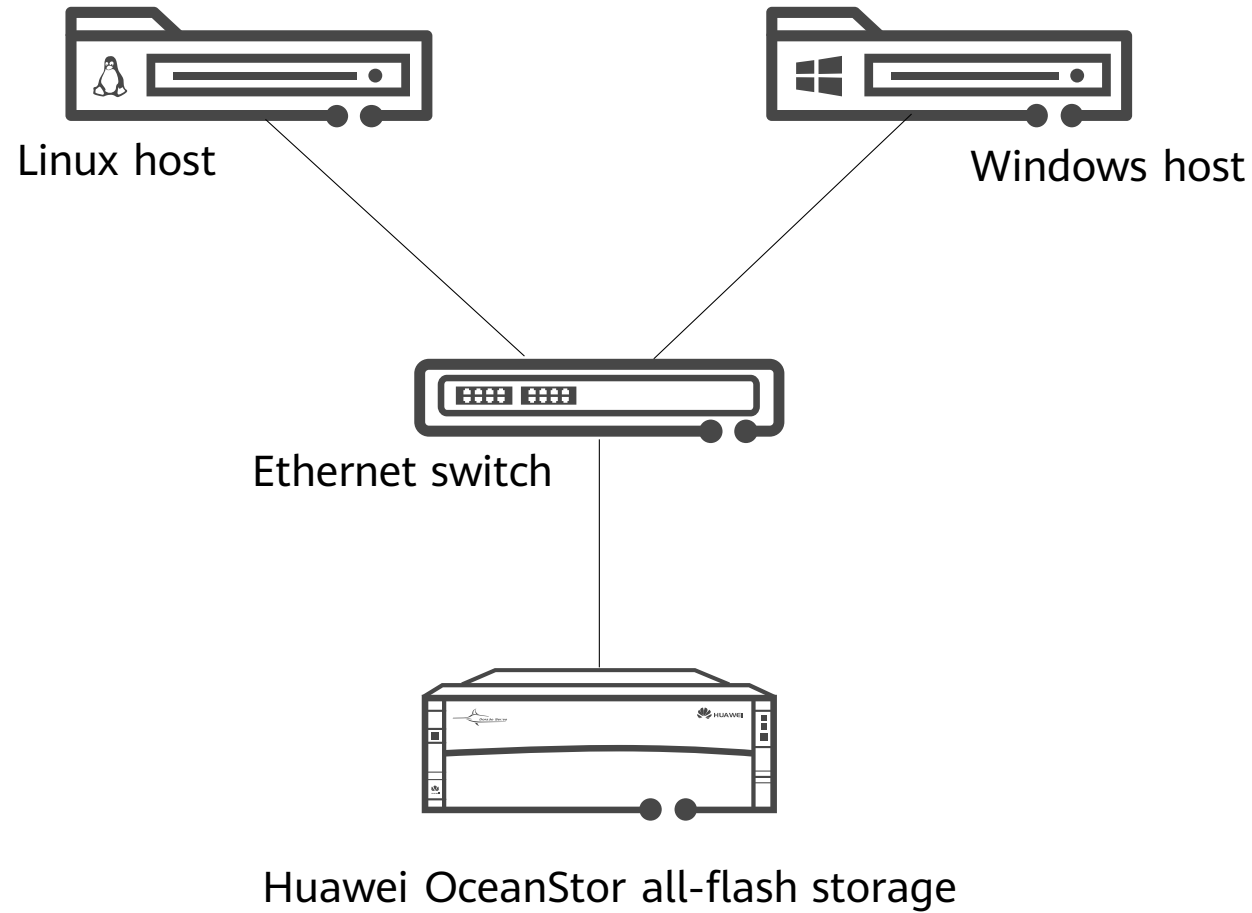

Practice Mode

Objectives

- You will be able to use DeviceManager to check devices and collect logs.
- You will be able to use DeviceManager to check devices and collect logs.
- You will be able to use SmartKit to inspect devices and collect logs.

Procedure

- Topic introduction
- Case study
- Scenario-based practice
- Presentation
- Evaluation and feedback

Opinion
Sharing

Form

- Two or three persons form a group.
- Each group prepares materials for presentation.
- After the presentation of each group, the technical officer asks questions, and the evaluator gives feedback and scores.

Assessment Criteria

- Accuracy
- Completeness
- Presentation
- Time control

Question

- As a storage O&M engineer, what are the routine maintenance items?
- Suggested answer:

Item	Operation	
Checking and handling alarms	Log in to DeviceManager or use the configured alarm reporting mode to view alarms. Handle the alarms in a timely manner based on the suggestions. If the alarm persists, use SmartKit to collect related information and contact Huawei technical support.	Daily maintenance item
Item	Operation	
Storage system inspection	On the maintenance terminal, use the SmartKit inspection tool to check the hardware status, software status, value-added services, alarms, and other items. If you cannot resolve the problem according to suggestions provided by SmartKit, use SmartKit to collect related information and contact Huawei technical support.	Weekly maintenance item
Checking the storage system environment	Check the environment of equipment rooms and cabinets, such as temperature and humidity. If the requirements are not met, adjust the equipment room environment based on related specifications.	
Checking the cabinet internal environment	Check whether the internal environment of cabinets meets the requirements, such as requirements for cables, power cables and ground cables. If the requirements are not met, adjust the internal environment of cabinets based on related requirements.	

Scenario 1: Checking Storage Device Status



Checking Storage Device Status
(DeviceManager and CLI)

Viewing or Managing
License Files

Task 1: Using DeviceManager to Perform O&M Checks

- View device details.
- View alarms.
- Check the information about controllers and disks.
- Check the information about BBUs and fans.
- Check the storage pool status.
- Check the storage LUN status.
- Export log files.

Task 2: Performing O&M Checks on the CLI

- Log in to the storage system.
- Query system information.
- Query parts information.
- Query details about a LUN.
- Query storage pool information.

Task 3: Managing License Files

- View license information.
- Back up the license file.
- Query license information (CLI).

Scenario 2: SmartKit Inspection



Inspecting Storage Devices on
SmartKit and Collecting Logs

Task 1: Inspecting Storage Devices on SmartKit and Collecting Logs

- Install the software.
- Run the software.
- Add devices.
- Inspect devices.
- Collect logs.
- (Optional) Check the health of disks.

Trainee Assessment

Item	Description	Score	Rating
Accuracy	The trainee's explanation is logical and fluent.	1 to 10	
Completeness	The answers presented by the trainee are complete.	1 to 20	
Presentation	The trainee presents answers clearly.	1 to 10	
Time control	The trainee provides the correct answers within the specified time.	1 to 10	
Overall		/	

Thank you.

把数字世界带入每个人、每个家庭、
每个组织，构建万物互联的智能世界。

Bring digital to every person, home, and
organization for a fully connected,
intelligent world.

**Copyright©2020 Huawei Technologies Co., Ltd.
All Rights Reserved.**

The information in this document may contain predictive statements including, without limitation, statements regarding the future financial and operating results, future product portfolio, new technology, etc. There are a number of factors that could cause actual results and developments to differ materially from those expressed or implied in the predictive statements. Therefore, such information is provided for reference purpose only and constitutes neither an offer nor an acceptance. Huawei may change the information at any time without notice.



Huawei Storage Certification Training

HCIA-Storage

Scenario-based Practice of Storage O&M Management

(For Trainees)



HUAWEI

HUAWEI TECHNOLOGIES CO., LTD.

Copyright © Huawei Technologies Co., Ltd. 2020. All rights reserved.

No part of this document may be reproduced or transmitted in any form or by any means without prior written consent of Huawei Technologies Co., Ltd.

Trademarks and Permissions



and other Huawei trademarks are trademarks of Huawei Technologies Co., Ltd.

All other trademarks and trade names mentioned in this document are the property of their respective holders.

Notice

The purchased products, services and features are stipulated by the contract made between Huawei and the customer. All or part of the products, services and features described in this document may not be within the purchase scope or the usage scope. Unless otherwise specified in the contract, all statements, information, and recommendations in this document are provided "AS IS" without warranties, guarantees or representations of any kind, either express or implied.

The information in this document is subject to change without notice. Every effort has been made in the preparation of this document to ensure accuracy of the contents, but all statements, information, and recommendations in this document do not constitute a warranty of any kind, express or implied.

Huawei Technologies Co., Ltd.

Address: Huawei Industrial Base Bantian, Longgang Shenzhen 518129
People's Republic of China

Website: <http://e.huawei.com>

Huawei Certificate System

Huawei Certification follows the "platform + ecosystem" development strategy, which is a new collaborative architecture of ICT infrastructure based on "Cloud-Pipe-Terminal". Huawei has set up a complete certification system consisting of three categories: ICT infrastructure certification, Platform and Service certification and ICT vertical certification, and grants Huawei certification the only all-range technical certification in the industry.

Huawei offers three levels of certification: Huawei Certified ICT Associate (HCIA), Huawei Certified ICT Professional (HCIP), and Huawei Certified ICT Expert (HCIE).

Huawei Certified ICT Associate-Storage (HCIA-Storage) is designed for Huawei engineers, students and ICT industry personnel. HCIA-Storage covers knowledge about storage technology trends, storage basic technologies, storage common advanced technologies, storage business continuity solutions and storage system O&M management.

The HCIA-Storage certificate system introduces you to the industry and market, helps you in innovation, and enables you to stand atop the Storage frontiers.

Huawei Certification Portfolio

Huawei Certification





Contents

1 References and Tools	4
1.1 References	4
1.2 Software Tools	4
1.3 Version Description	5
2 Scenario-based Practice of Storage O&M management.....	6
2.1 Course Overview	6
2.2 Objectives	6
2.3 Case Background	6
2.4 Tasks.....	7
2.4.1 Scenario 1: Checking Storage Device Status	7
2.4.2 Scenario 2: Inspecting Storage Devices on SmartKit.....	13
2.5 Summary and Conclusion	16

1 References and Tools

Commands and documents listed in this document are for reference only. Use the corresponding commands and documents based on the product version in the actual environment.

1.1 References

1. Huawei OceanStor Dorado V6 Product Documentation

NOTE

You can log in to Huawei's technical support website (<https://support.huawei.com/enterprise/>) and input the name of a document or tool in the search box to search for, browse, and download the document or tool.

2. Huawei SmartKit Product Documentation

NOTE

You can log in to Huawei's technical support website (<https://support.huawei.com/enterprise/>) and input the name of a document or tool in the search box to search for, browse, and download the document or tool.

1.2 Software Tools

1. PuTTY

NOTE

You are advised to use the open-source software PuTTY to log in to a terminal. You can use the common domain name (putty.org) of PuTTY to browse or download the corresponding document or tool.

2. SmartKit

NOTE

You can log in to Huawei's technical support website (<https://support.huawei.com/enterprise/>) and input the name of a document or tool in the search box to search for, browse, and download the document or tool.

1.3 Version Description

The recommended platform and software versions in the practice tasks are as follows:

Name	Version	Quantity	Remarks
Huawei storage	Huawei OceanStor Dorado V6	1	None
SmartKit software	SmartKit V2R7C00RC1	--	This version or later is recommended.
Windows OS	Windows Server 2012 or Windows Server 2016	--	Recommended version
Linux OS	SUSE, Red Hat, CentOS, or EulerOS	--	Recommended version

2 Scenario-based Practice of Storage O&M management

2.1 Course Overview

Based on the previous study, this course provides case study and scenario-based practices to help trainees consolidate the previous study and equip them with storage device O&M management capabilities.

2.2 Objectives

- You will be able to use DeviceManager to check devices and collect logs.
- You will be able to use CLI commands to query basic information about device components and resource pools.
- You will be able to use SmartKit to inspect devices and collect logs.

2.3 Case Background

NOTE

Cases in this document are examples only. The actual configurations may vary according to actual environments. For details, see the corresponding product document. The names of storage pools and LUNs involved in this document can be customized (for example, LUN_XXX) for different trainees if they use the same device.

An enterprise has completed the acceptance of project X. In this case, multiple Huawei OceanStor all-flash storage devices (such as Huawei OceanStor Dorado V6) are added to the data center. Devices have been installed and services have been deployed. Routine maintenance and management are required to ensure the normal running of devices and the stability and reliability of services.

If you are the administrator who is responsible for the management and maintenance of related devices, how do you perform routine inspection?

The following figure shows the topology of the enterprise:

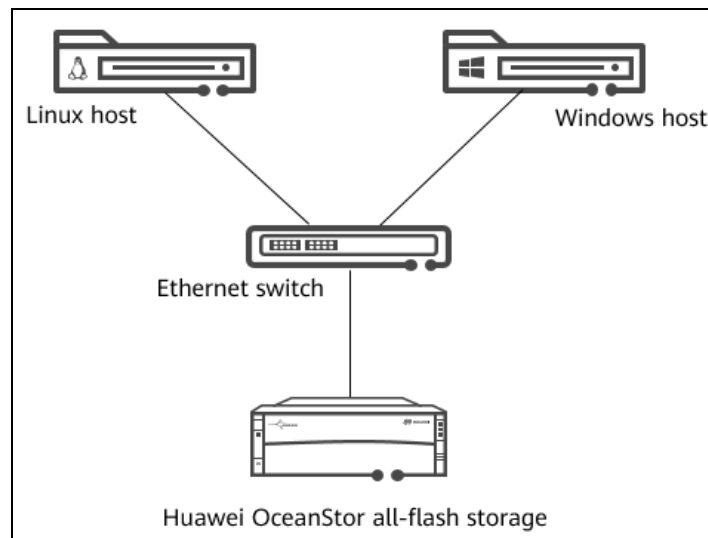

Figure 2-1 Network topology

2.4 Tasks

2.4.1 Scenario 1: Checking Storage Device Status

Background

O&M engineers need to periodically inspect storage devices based on the plan, for example, check whether alarms are generated and check the resource usage, to learn about the running status of parts in a timely manner. Once a fault occurs on the storage device, the fault can be detected and rectified as soon as possible to ensure service security and reliability.

If you are an engineer, how will you perform the inspection?

Question

As a storage O&M engineer, what are the routine maintenance items?

Item	Operation	Daily maintenance item
Item	Operation	Weekly maintenance item

Task 1: Performing O&M Checks on DeviceManager

Step 1 View device details.

Log in to DeviceManager and view storage system information, such as the health status, storage version, and ESN.



[Suggested Procedure]

For details, see **Operation and Maintenance > Administrator Guide > Routine Maintenance > Manual Inspection > Checking the Running Status of the Storage Device** in the desired product documentation.

Step 2 View alarms.

View the alarm information of a storage system on DeviceManager.



[Suggested Procedure]

For details, see **Operation and Maintenance > Administrator Guide > Routine Maintenance > Manual Inspection > Viewing and Handling Alarms** in the desired product documentation.

Step 3 Check the status of parts such as controllers and disks.

On DeviceManager, check the status of controller enclosures, controllers, disks, and ports.

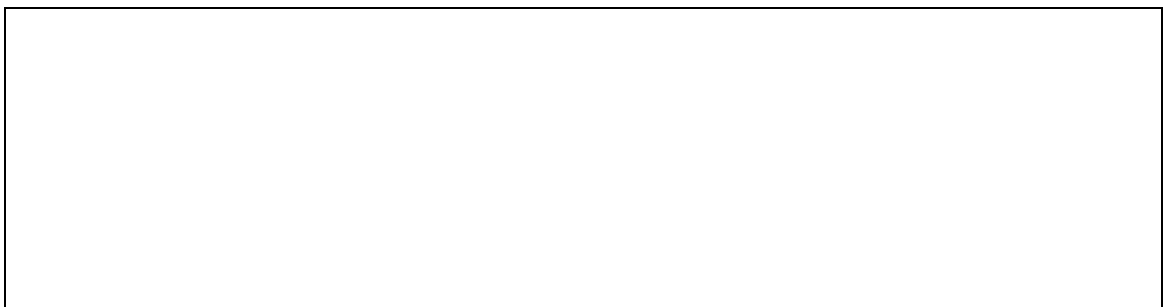

[Suggested Procedure]

For details, see **Operation and Maintenance > Administrator Guide > Routine Maintenance > Manual Inspection > Checking the Running Status of the Storage Device > Checking the Storage System Inventory** in the desired product documentation.

Step 4 Check the status of BBUs and fan modules.

Use DeviceManager to query the status of parts such as BBUs, fan modules, and power modules.



[Suggested Procedure]

For details, see **Operation and Maintenance > Administrator Guide > Routine Maintenance > Manual Inspection > Checking the Running Status of the Storage Device > Checking Controller Enclosure BBUs/Checking Fan Modules/Checking Power Modules** in the desired product documentation.

Step 5 Check the storage pool status.

On DeviceManager, check the storage pool status and its usage.

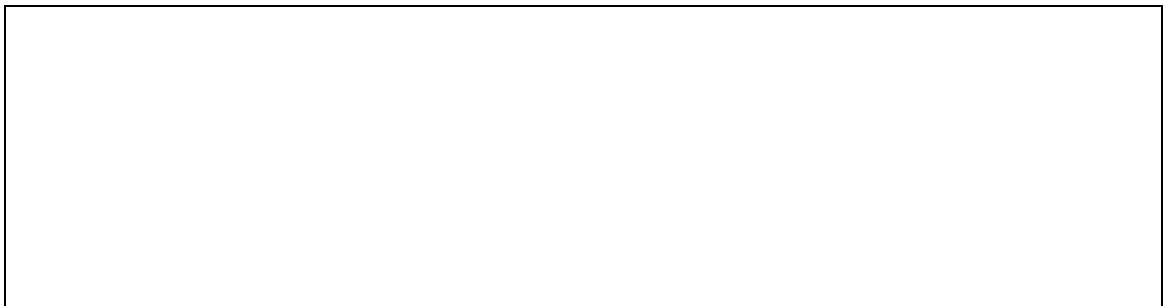

[Suggested Procedure]

For details, see **Operation and Maintenance > Administrator Guide > Routine Maintenance > Manual Inspection > Checking the Running Status of Services > Checking Storage Pools** in the desired product documentation.

Step 6 Check the storage LUN status.

Use DeviceManager to check the LUN usage and status.

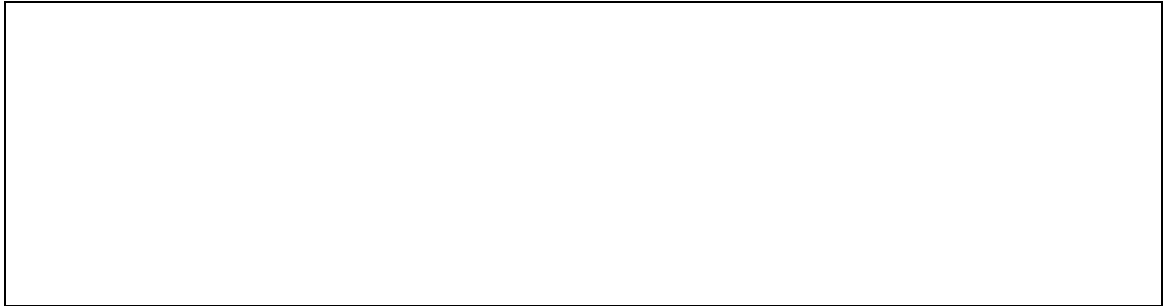

[Suggested Procedure]

For details, see **Operation and Maintenance > Administrator Guide > Routine Maintenance > Manual Inspection > Checking the Running Status of Services > Checking LUNs** in the desired product documentation.

Step 7 Export log files.

Use DeviceManager to export system logs and diagnosis files.



[Suggested Procedure]

For details, see **Operation and Maintenance > Administrator Guide > Routine Maintenance > Collecting Storage System Information > Collecting Logs and Alarms Using DeviceManager > Exporting System Data** in the desired product documentation.

Task 2: Performing O&M Checks on the CLI

Step 1 Log in to the storage system.

Log in to the storage system using the CLI.

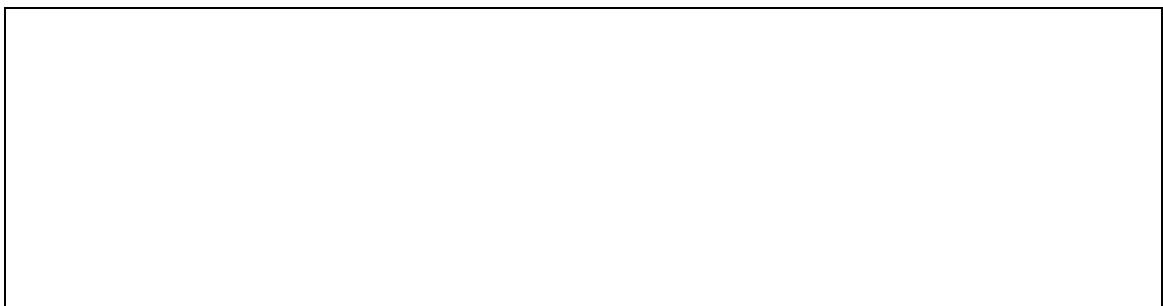

[Suggested Procedure]

For details, see **Installation and Upgrade > Initialization Guide > Logging In to the CLI** in the desired product documentation.

Note: You can use the IP address of the management network port to log in.

Step 2 Query system information.

Query the storage system information on the CLI.



[Suggested Procedure]

For details, see **Reference > Command Reference > Basic Operation Commands > base > show system general** in the desired product documentation.

Step 3 Query parts information.

1. Query the disk information on the CLI.
2. Query the controller information on the CLI.
3. Query the fan module information on the CLI.
4. Query the BBU information on the CLI.

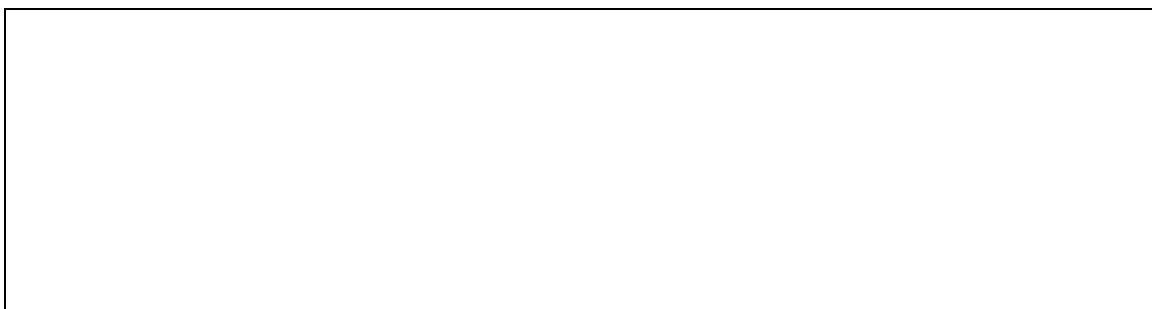

[Suggested Procedure]

For details, see:

1. **Reference > Command Reference > Hardware Management Commands > disk > show disk general;**
2. **Reference > Command Reference > Hardware Management Commands > controller > show controller general;**
3. **Reference > Command Reference > Hardware Management Commands > fan > show fan;**
4. **Reference > Command Reference > Hardware Management Commands > bbu > show bbu general.**

Step 4 Query details about a LUN.

Use the CLI to query LUN information.

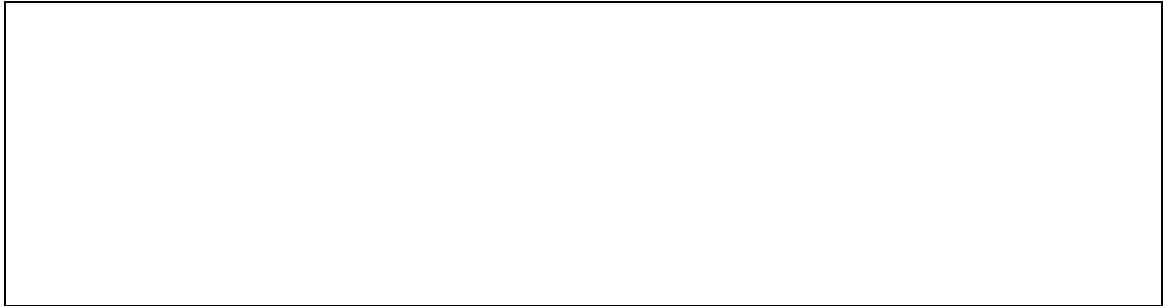

[Suggested Procedure]

For details, see **Reference > Command Reference > Storage Domain Management Commands > lun > show lun general** in the desired product documentation.

Step 5 Query storage pool information.

Use the CLI to query storage pool information.

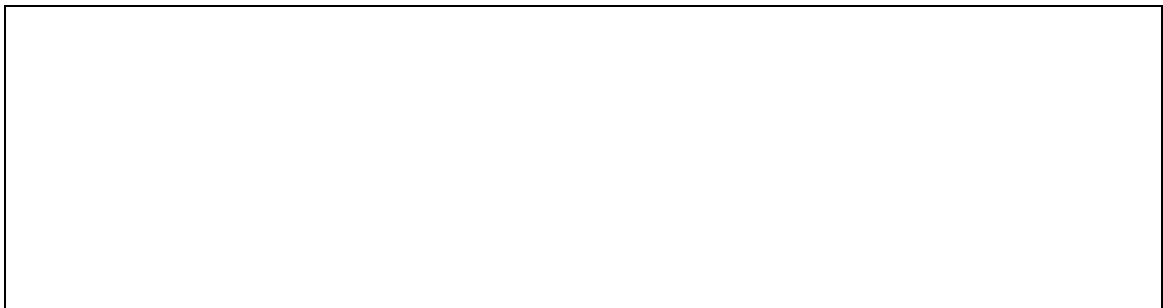

[Suggested Procedure]

For details, see **Reference > Command Reference > Storage Domain Management Commands > storage_pool > show storage_pool general** in the desired product documentation.

Task 3: Managing License Files

Step 1 View license information.

View the license information of a storage system on DeviceManager.

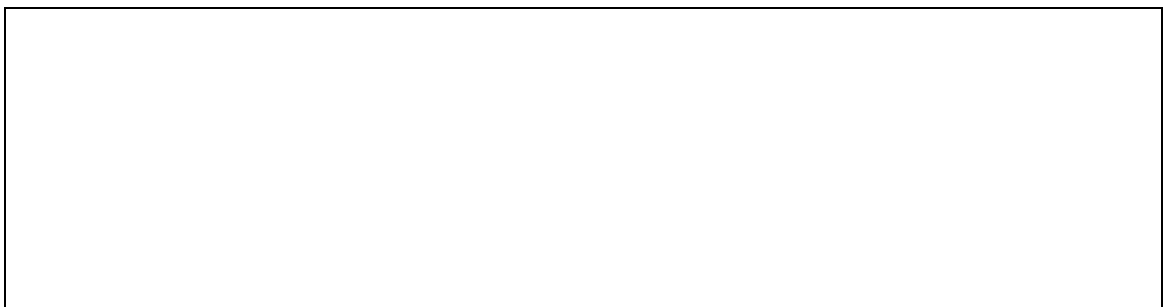

[Suggested Procedure]

Log in to the storage system through DeviceManager and check the license of the storage system. Pay attention to the license authorization items, expiration time, and licensed capacity.

For details, see **Operation and Maintenance > Administrator Guide > Routine Management > Managing License Files > Viewing an Activated License File** in the desired product documentation.

Step 2 Back up the license file.

Query the storage system information on the CLI.

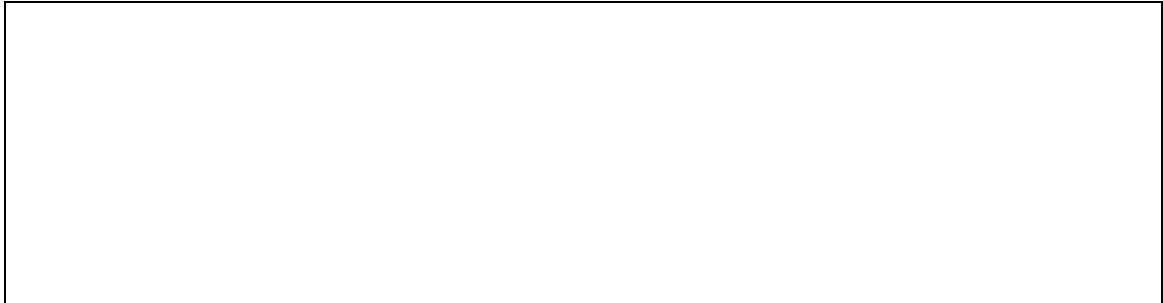

[Suggested Procedure]

For details, see **Operation and Maintenance > Administrator Guide > Routine Management > Managing License Files > Backing Up an Activated License File** in the desired product documentation.

Step 3 Query license information.

Query license information of the storage system in the CLI.

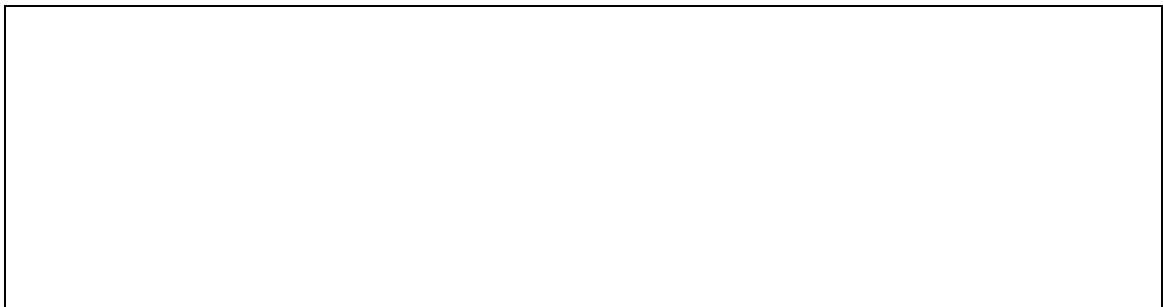

[Suggested Procedure]

For details, see **Reference > Command Reference > License Management Commands > license > show License** in the desired product documentation.

2.4.2 Scenario 2: Inspecting Storage Devices on SmartKit

Background

Due to service requirements, a company adjusts (for example, migration) its storage devices. O&M engineers need to check the adjusted devices to ensure that the devices are running properly and collect logs. Check items include the device running status, device port status, and disk health status.

If you are engineer A, how do you use SmartKit to check storage devices?

Question

What are the typical application scenarios of SmartKit?

Task 1: Performing Inspection on SmartKit

Step 1 Install the software.

Install SmartKit on the management host. If it has been installed, run it directly.

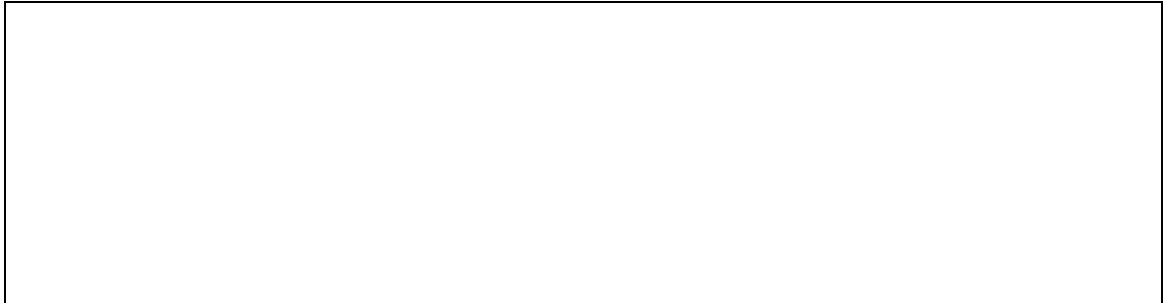

[Suggested Procedure]

After obtaining the software, double-click the software to start installation, and install the software as prompted.

Step 2 Run the software.

Run SmartKit.

Note: After the software is started, the system may prompt you to log in. If you have an account, click **Authenticate Now** and use the account to log in. If you do not have an account, select **Authenticate Later**.



[Suggested Procedure]

For details, see **Operation and Maintenance > Administrator Guide > Common Management Software and Access Method > Logging In to the Storage System O&M Software** in the desired product documentation.

Step 3 Add devices.

Add storage devices to be inspected on SmartKit.



[Suggested Procedure]

For details, see **Operation and Maintenance > Administrator Guide > Routine Maintenance > Inspection Using SmartKit** in the desired product documentation.

Step 4 Inspect devices.

Inspect the newly added devices on SmartKit.



[Suggested Procedure]

For details, see **Operation and Maintenance > Administrator Guide > Routine Maintenance > Inspection Using SmartKit** in the desired product documentation.

Step 5 Collect logs.

Collect storage device information on SmartKit.



[Suggested Procedure]

For details, see **Operation and Maintenance > Administrator Guide > Routine Maintenance > Inspection Using SmartKit** in the desired product documentation.

Step 6 (Optional) Check the health of disks.

Analyze disk health on SmartKit.

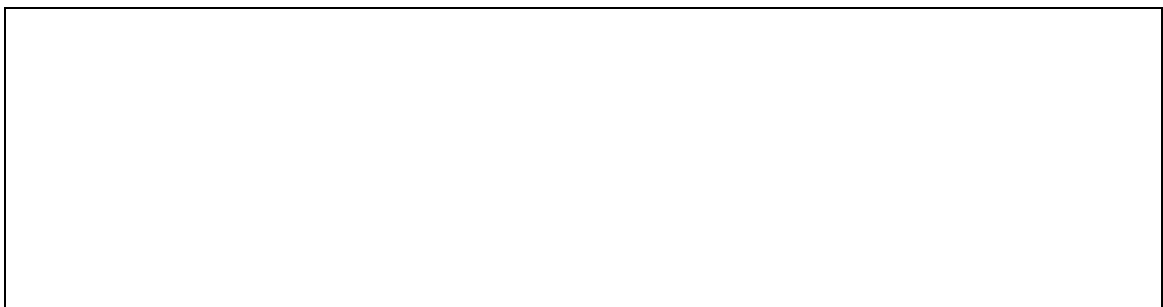

[Suggested Procedure]

For details, see **Operation and Maintenance > Administrator Guide > Routine Maintenance > Inspection Using SmartKit** in the desired product documentation.

Note: If the SmartKit version to be installed is used only in Chinese Mainland, this step may fail. If the device uses Huawei OceanStor eStor simulator, some information in the analysis report may be incomplete.

Discussion

What information needs to be collected when a fault occurs on a device?

Information Type	Item	Description
Basic Information		
Fault information		
Storage device information		
Networking information		
Application server information		

2.5 Summary and Conclusion

My Opinion:
